



Thread milling cutters & gauges series

# THREAD MILLS

Volume 6



# INDEX

---

## **THREAD MILLING** (Pre-drilled hole necessary)

### Metric, metric fine

AT-1 .....	PAGE 14
WX-PNC .....	PAGE 15
WXO-ST-PNC .....	PAGE 16
WX-ST-PNC-3P .....	PAGE 17
WH-VM-PNC .....	PAGE 18

### Unified

AT-1 .....	PAGE 19
WX-PNC .....	PAGE 20
WH-VM-PNC .....	PAGE 21

### G

AT-1 .....	PAGE 23
WX-PNC .....	PAGE 25
WXO-ST-PNC-3P .....	PAGE 26

### Rc

AT-1 .....	PAGE 22
WX-PNC .....	PAGE 27

### NPT

AT-1 .....	PAGE 24
WX-PNC .....	PAGE 28

## **THREAD MILLING** (No pre-drilled hole necessary)

### Metric, metric fine

AT-2 .....	PAGE 40
WH-EM-PNC .....	PAGE 55-56
WHO-EM-PNC .....	PAGE 53

### U, UNJ, UNC, UNJC, UNF, UNJF

AT-2 .....	PAGE 41
------------	---------

### Rc (PT), NPT







AT-2 .....	PAGE 42-43
------------	------------



# THREAD GAUGES

DCT (M, UNJF) .....	PAGE 61-62
E-DCT (MJ, UNJC, UNJF) .....	PAGE 67-68
DCT75 (MJ, U, RPT) .....	PAGE 69-71
DCT75 DIGITAL INDICATOR .....	PAGE 72-73

# THREAD MILLS OVERVIEW & WORK MATERIALS

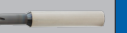
		AT-1	WX-PNC	WYO-ST-PNC	WX-ST-PNC-3P	WH-VM-PNC	AT-2	WH-EM-PNC	WHO-EM-PNC
									
<b>Thread types</b>		M, MF, U, UNJ, UNC, UNJC, UNF, UNJF, Rc, G, NPT	M, MF, UNJ, UNC, UNF, UNJC, UNJF, G, Rc, NPT	M, MF	M, MF, G	M, MF, U, UNJ, UNC, UNJC, UNF, UNJF	M, MF, U, UNJ, UNC, UNJC, UNF, UNJF	M, MF	M, MF
<b>Oil hole</b>		-	-	Y	-		Y (M10, M12)	-	Y
<b>LxD</b>		2xD	2xD	2xD	2,5xD	2xD	2xD, 2,5xD	2xD	2xD
<b>Chamfer</b>		-	-	-	-	-	Y	Y	Y
<b>Threading without pre-drilled hole</b>		-	-	-	-	-	Y	Y	Y
<b>P</b>	C:≤0,2%	⊙	○	○	○	○			
	C:0,25-0,45%	⊙	○	⊙	○	○			
	C:≥0,45%	⊙	○	⊙	○	○	○	○	○
	SCM	⊙	○	⊙	○	○	○	○	○
<b>M</b>	INOX	⊙	○	○	○	○			
<b>K</b>	GG	⊙	○	○	○	○			
	GGG	⊙	○	○	○	○			
<b>N</b>	Al	⊙	○	○	○	○			
	AC, ADC	⊙	○	○	○	○			
<b>S</b>	Ti		⊙		⊙	⊙	○	○	○
	Ni		⊙		⊙	⊙	○	○	○
<b>H</b>	25~35HRC	⊙	○	⊙	⊙	⊙	⊙	⊙	⊙
	35~45HRC	⊙	○	⊙	⊙	⊙	⊙	⊙	⊙
	45~52HRC						⊙	⊙	⊙
	52~62HRC						○	○	○

○ :Good    ⊙ :Very Good

# KEY FEATURES: AT-1

**1** Unequal spacing with variable lead flute reduces vibration

**2** Right-hand cut & left-hand helix geometry prevents bending

**3** EgiAs coating with exceptional wear resistance and toughness

**4** Ultra-Fine Grain Carbide with high wear resistance and toughness



# AT-1: THE SECRET TO 1-PASS CUTTING

## The secret to 1-pass cutting

Evolution from conventional 2-pass cutting to 1-pass cutting by preventing bending, reducing cutting time.

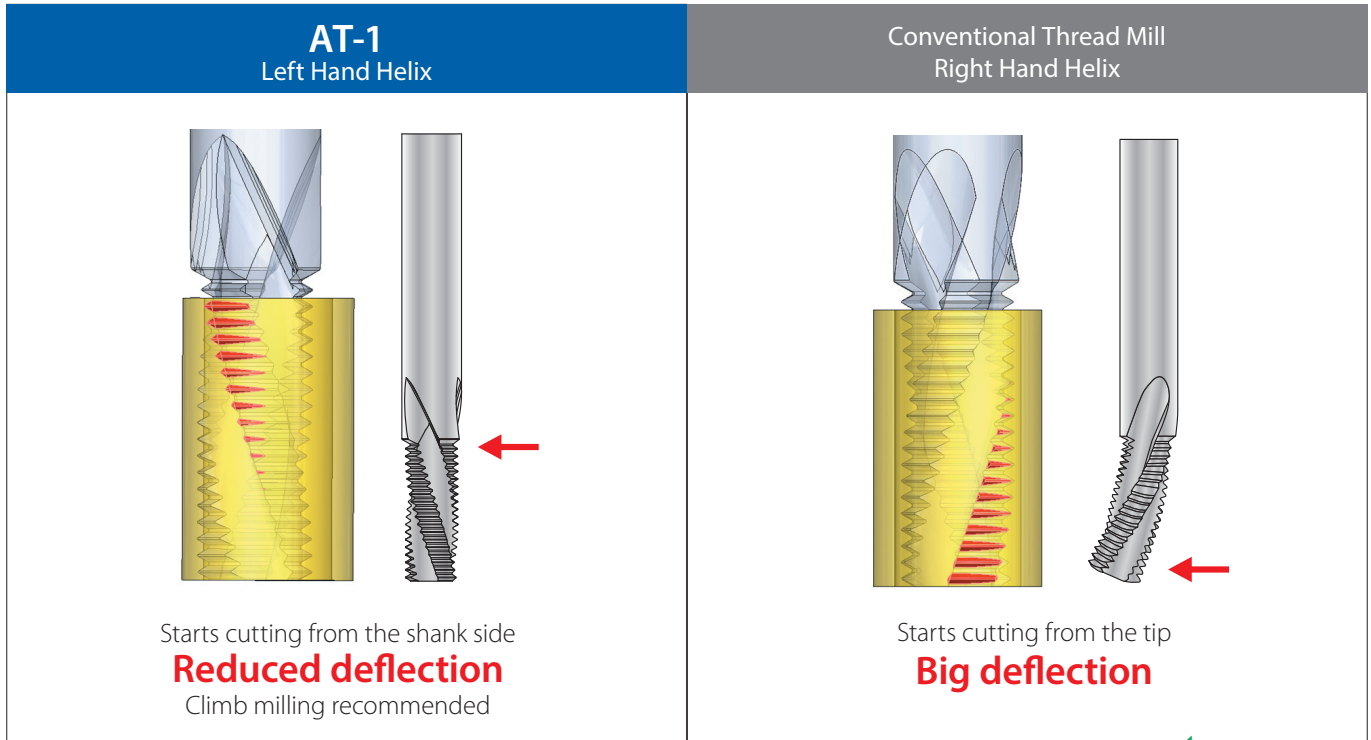

## High quality internal threading

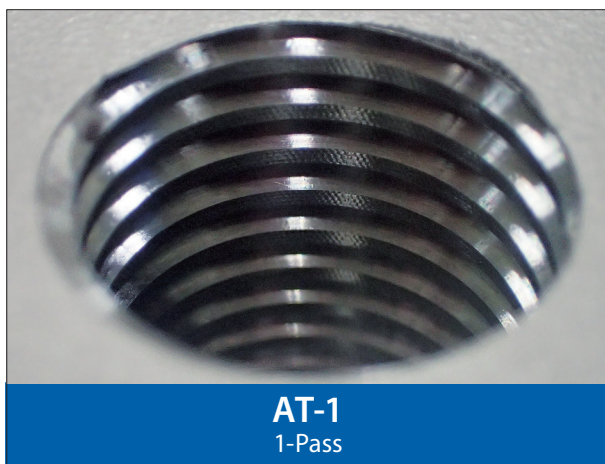

Size	Ø19,7 x 54 P3 6F
Work Material	SUS304
Cutting Speed	40 m/min (646min <sup>-1</sup> )
Feed	14 mm/min (0,02mm/t)
Internal Thread Size	M24 x 3
Tapping length	45 mm
Coolant	Water-Soluble
Machine	Horizontal Machining Center

# SUPPORT TOOLS FOR YOUR THREAD MILLING NEEDS

## 1 RPRG

Use RPRG to reduce the workload. RPRG is the reference value of tool radius offset.

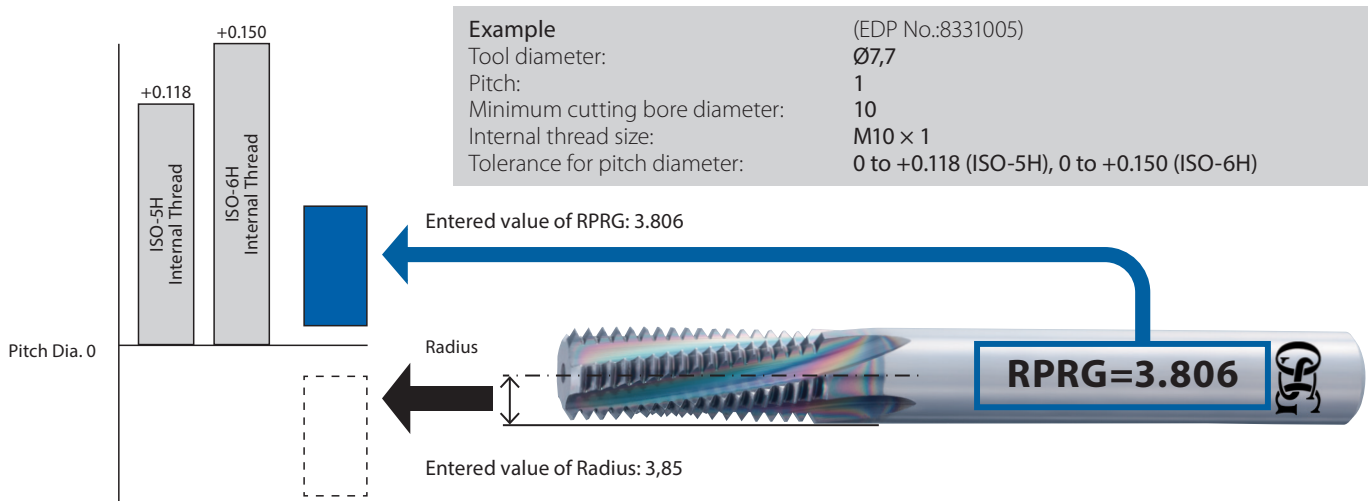

### Notes

1. RPRG are reference values. Optimal values for actual cutting depend on the machining environment. Determine optimal values after trial cutting.
2. RPRG values are optimally established to achieve ISO:5H (formerly Grade 1) internal thread limits for metric threads and ANSI:3B internal thread limits for unified threads. RPRG values established for taper pipes (R/Rc) are effective when using the thread milling NC code generator software ThreadPro available on our website.
3. For diameters of thread mills, RPRG values are calculated based on the minimum cutting bore diameter (the minimum cutting internal thread size of the tool diameter). To cut other diameters, it is necessary to use a smaller value than RPRG.

## 2 Revamped Thread Milling NC Code Generator Software "ThreadPro"

Create machining programs at ease with OSG's revamped NC code generator software ThreadPro.



## 3 Achieve stable tool life with the DCT for accurate diameter measurement

The internal thread effective diameter, which used to be difficult to determine, can now be measured with readable values.

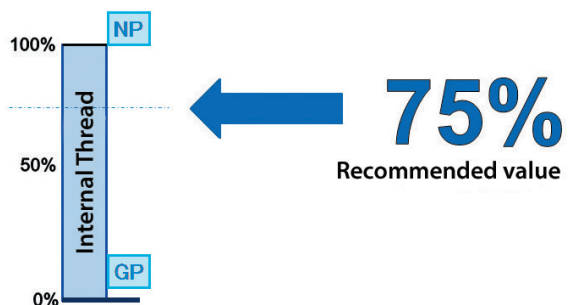

## Troubled by the following problems?

<p>Unsure of diameter correction value. Increase passes which results in longer setup time.</p>	<p>An incorrect diameter correction that result in a defective internal thread (gauge-out).</p>	<p>Unstable tool life</p>
---	---	---------------------------

## Solved with the Diameter Correction Tool DCT



Simple measurement of pitch diameter by visual judgment

<p>Visibility of internal thread pitch diameter at entry enables the reduction of passes to minimize setup time significantly. Moreover, the DCT is able to measure pitch diameter smaller than the tolerance limit. The DCT can measure the pitch diameter of the female internal thread even if it does not fit into the Go-Gauge.</p>	<p>Visibility of internal thread pitch diameter at entry enables reliable diameter corrections. The DCT is useful for reducing defective workpieces.</p>	<p>Digitized measurement ensures consistent internal thread pitch diameters after tool changes. The same starting and finishing position ensures consistent and stable tool life.</p>
--	--	---



# ADVANTAGES OF USING THREAD MILLS

## A single tool cuts various sizes of diameters

A single tool can cut different threads such as M10 × 1.5, M12 × 1.5, and M16 × 1.5 if their pitch is the same.

## Cuts large-diameter threads on low-power machine

The internal thread effective diameter, which used to be difficult to determine, can now be measured with readable values.

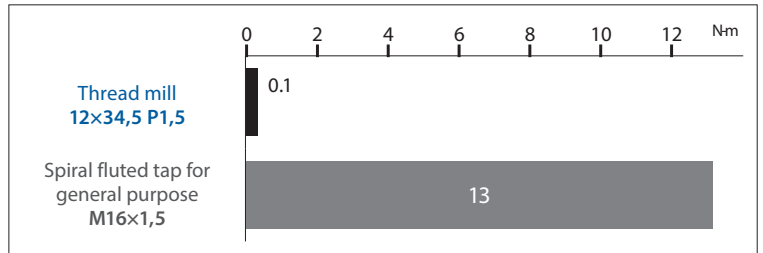

## Smooth handling of chips to reduce problems

Thread mills break chips into small pieces and eject them smoothly, ensuring stable, problem-free thread cutting.

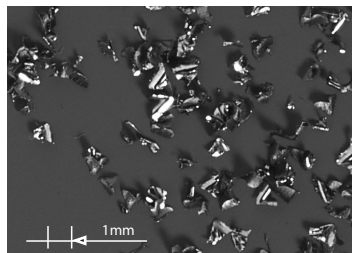

Thread mill chips  
Material S45C

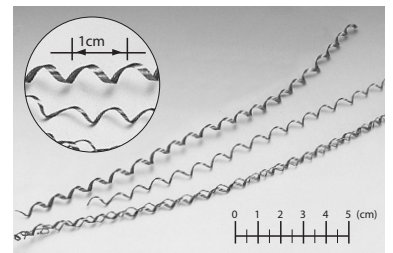

Spiral fluted tap chips

## High-precision taper pipe threading (no stop marks)

Airtight threads by having no stop marks.

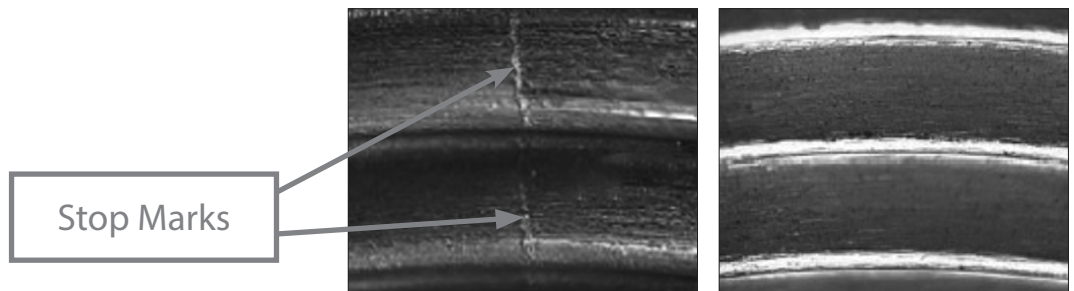

## Thread cutting in drill holes with little allowance

Thread milling cuts the thread closer to the bottom of a hole than tapping, leaving only one incomplete crest of thread





# CUTTING DATA

## Effects of left-hand helix

Comparison of differences in internal thread pitch diameter at initial cutting stage.

Size	Ø7,7 × 22 P1 4F
Work Material	SCM440 (30 HRC)
Cutting Speed	100 m/min (4.136min <sup>-1</sup> )
Feed	380 mm/min (0,1mm/t)
Internal Thread Size	M10 x 1 mm
Drill Hole Size	Ø9 × 18 mm (Through)
Threading Length	15 mm
Machining Method	Climb milling 1-Pass
Coolant	Water-Soluble
Machine	Vertical Machining Center

The left-hand helix's small pitch diameter difference between the hole entry and inner hole allows a delay in gauge-out failure. Moreover, longer tool life can be achieved with "zero cutting" for correcting bending being eliminated.

	Hole Entry	Inner Hole Area	Dia. Difference
Right Hand Helix	+0,120 ~ +0,140	+0,040 ~ +0,060	0,060 ~ 0,100
Left Hand Helix	+0,120 ~ +0,140	+0,120 ~ +0,140	<b>0 ~ +0,020</b>

Pitch diameter measurement method : Step gauge

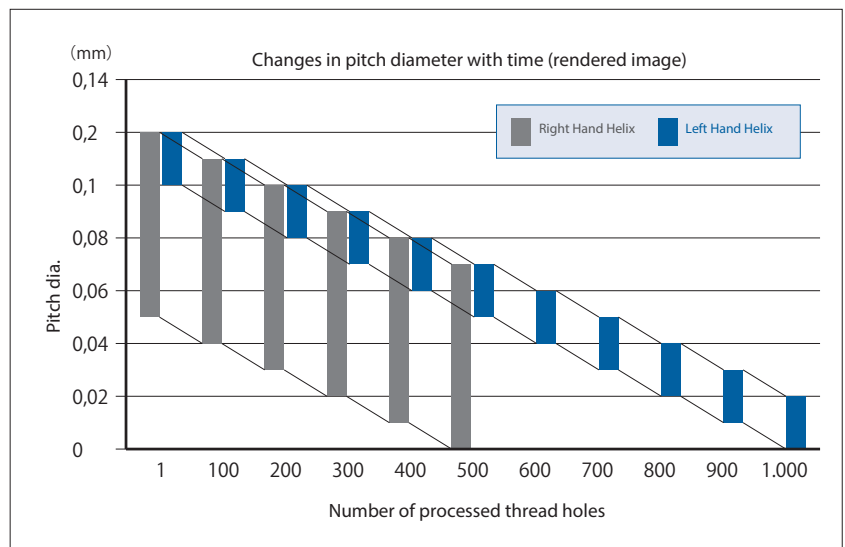

## Effects of EgiAs coating

Cutting edge after threading 2.000 holes.

Size	Ø7,7 × 22 P1 4F
Work Material	SCM440 (30 HRC)
Cutting Speed	100 m/min (4.136min <sup>-1</sup> )
Feed	380 mm/min (0,1mm/t)
Internal Thread Size	M10 x 1 mm
Drill Hole Size	Ø9 × 18 mm (Through)
Threading Length	15 mm
Coolant	Water-Soluble
Machine	Vertical Machining Center

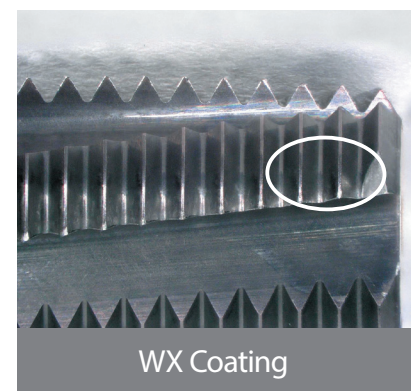
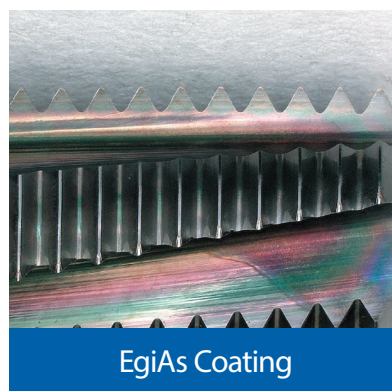



# CUTTING DATA

Work materials ① to ② are machined under the conditions shown below.

Internal Thread Size	M10 x 1 mm
Drill Hole Size	Ø9 x 25 mm (Blind)
Threading Length	19 mm
Coolant	Water-Soluble
Machine	Vertical Machining Center

1. Internal thread pitch diameter difference between hole entry and inner hole area: 20µm or less

Eg: +0.080 step gauge passes completely, +0.100 step gauge stops less than or equal to one revolution.

2. Fastest cutting condition (including number of passes) while fulfilling the requirement of Condition 1.

## ① Machining SUS304

Tool	AT-1 Ø7,7x22 P1 4F	Competitor
Cutting Speed	120m/min (4.961min <sup>-1</sup> )	140m/min (5.122min <sup>-1</sup> )
Feed	228mm/min (0,05mm/t)	200mm/min (0,1mm/t)
Number of Passes	1-Pass	2-Passes
Cutting Time	2,26 sec	3,03 sec

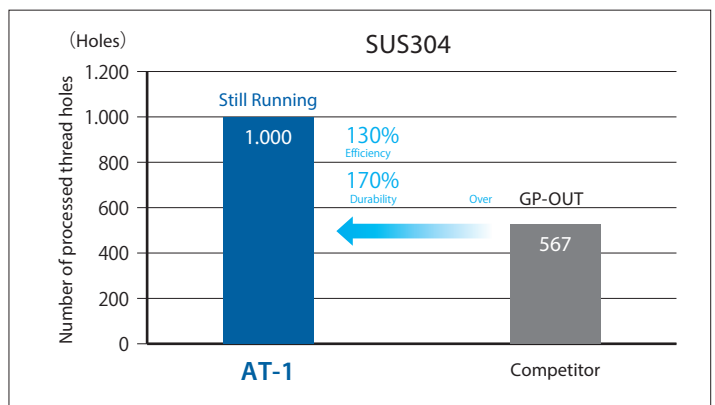

## ② Machining S50C

Tool	AT-1 Ø7,7x22 P1 4F	Competitor
Cutting Speed	160m/min (6.614min <sup>-1</sup> )	140m/min (5.122min <sup>-1</sup> )
Feed	122mm/min (0,02mm/t)	200mm/min (0,1mm/t)
Number of Passes	1-Pass	3-Passes
Cutting Time	4,28 sec	45,4 sec

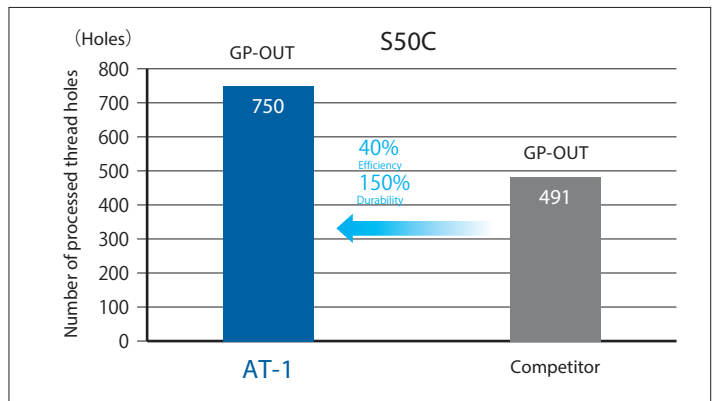

## ③ Machining SCM440

Tool	AT-1 Ø7,7x22 P1 4F	Competitor
Cutting Speed	80m/min (3.307min <sup>-1</sup> )	140m/min (5.122min <sup>-1</sup> )
Feed	30mm/min (0,01mm/t)	200mm/min (0,1mm/t)
Number of Passes	1-Pass	4-Passes
Cutting Time	17,12 sec	60,54 sec

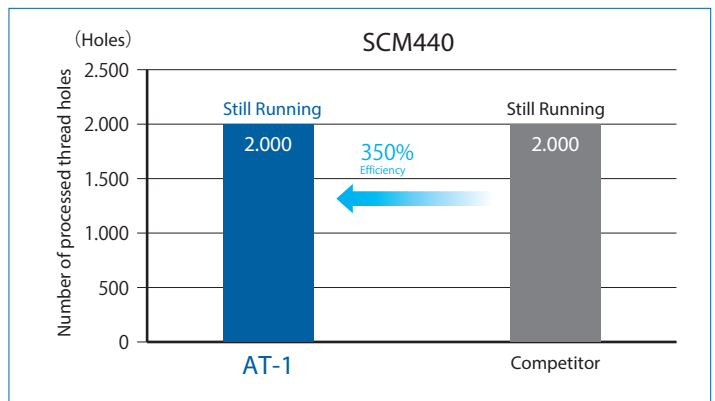

## SUS304 durability test result

Tool	AT-1	WX-ST-PNC
Work Material	SUS304	
Cutting Speed	100m/min	120m/min
Feed	12,5mm/min	42mm/min
Internal Thread Size	M12 x 1,5	
Drill Hole Size	Ø10,5 x 25 mm (Through)	
Threading Length	22,5 mm	
Coolant	Water-Soluble	
Machine	Vertical Machining Center	
Number of Passes	1-Pass	2-Passes

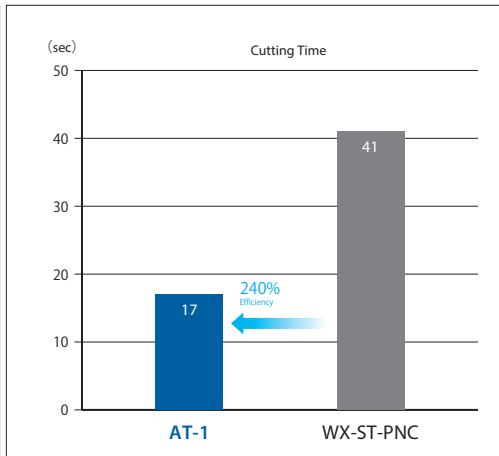
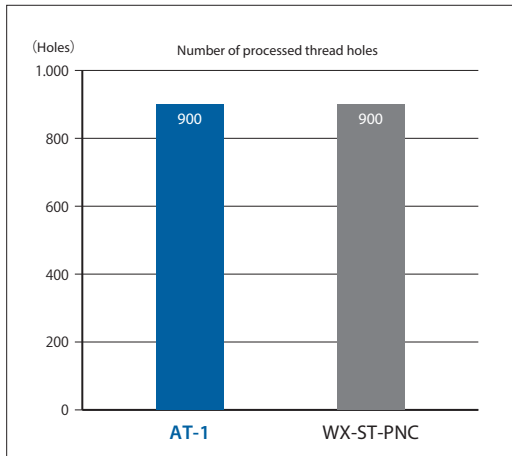

## SUPPORT TOOLS FOR YOUR THREAD MILLING NEEDS

Reduce setup, machining time, and achieve stable tool life with these 3 support tools.

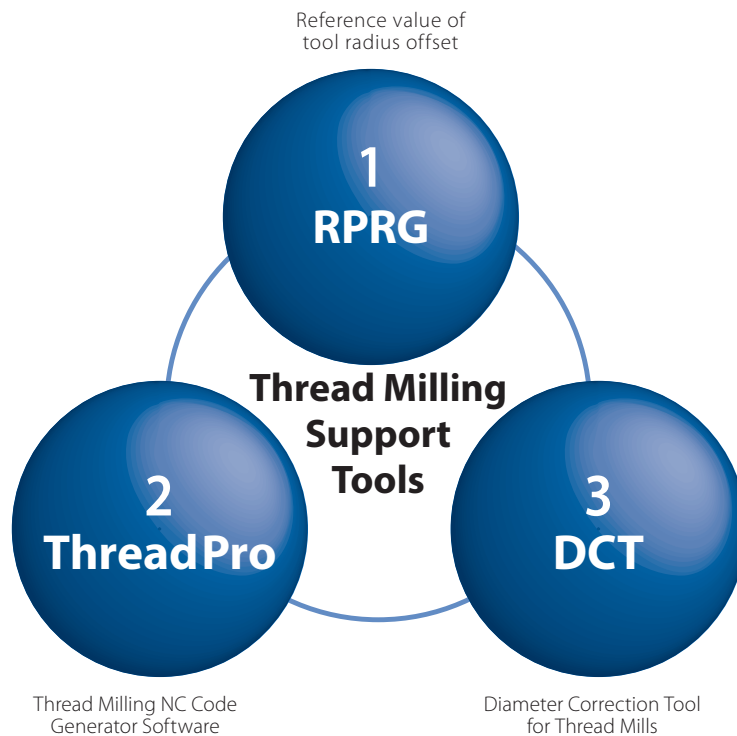

## Machining Tips

Taps and drill combination

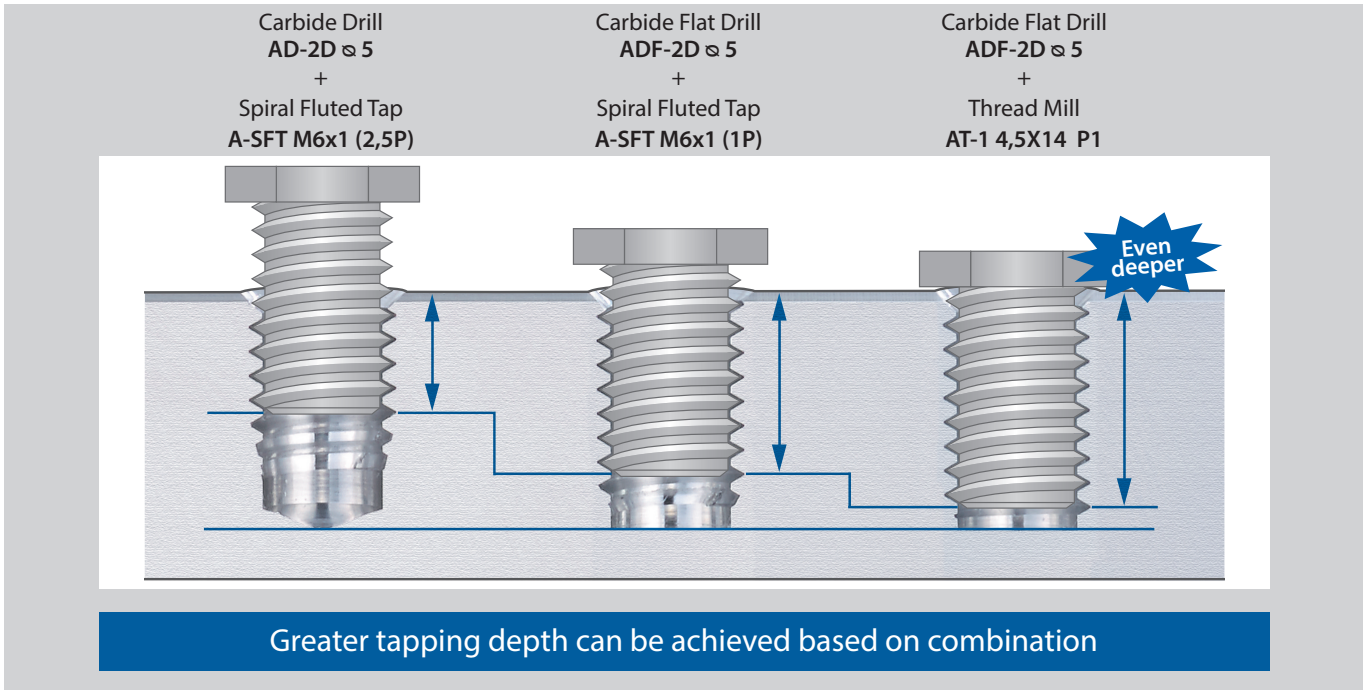

Threading | Thread milling

## Solve them with the Diameter Correction Tool (DCT)

DCT

Simple measurement of pitch diameter by visual judgment



DCT75

**Low-cost type**  
Measurement and calculation system

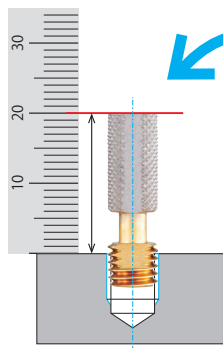

**High-performance type**  
Digital display system

Eliminate measurement and calculation with the combination of a digital display.

# Q&A FAQ ABOUT THREAD MILLING

## Why internal thread cutting tools cannot be used to cut external threads?

Metric and unified threads have different thread profiles between internal and external threads. For these threads, internal thread cutting tools cannot be used to cut external threads because in their basic thread profiles, the crest and root shapes are not uniform. However, for pipe threads, which have uniform crests and roots, thread cutting tools can be shared for internal and external thread cutting.

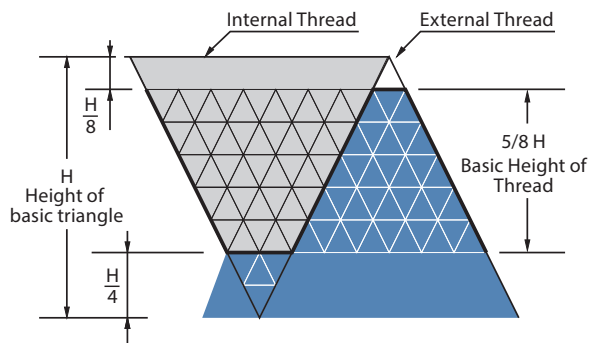

Compare the shapes of internal and external threads.

?	1/8 H	1/4 H
Height cut off from crest:	External Thread	Internal Thread
?	1/4 H	1/8 H
Height cut off at root:	External Thread	Internal Thread

Both threads have the same basic height of thread (5/8H). However, their shapes are different from each other.

Example of basic thread profile (metric thread)

## What does the number "75" under "Fit %" mean, which is displayed on the data entry screen of ThreadPro?

It means to aim at the acceptable range of threads. Default values are 75% (larger side) for internal threads and 25% (smaller side) for external threads in light of their engagement. You can change these to your desired values.

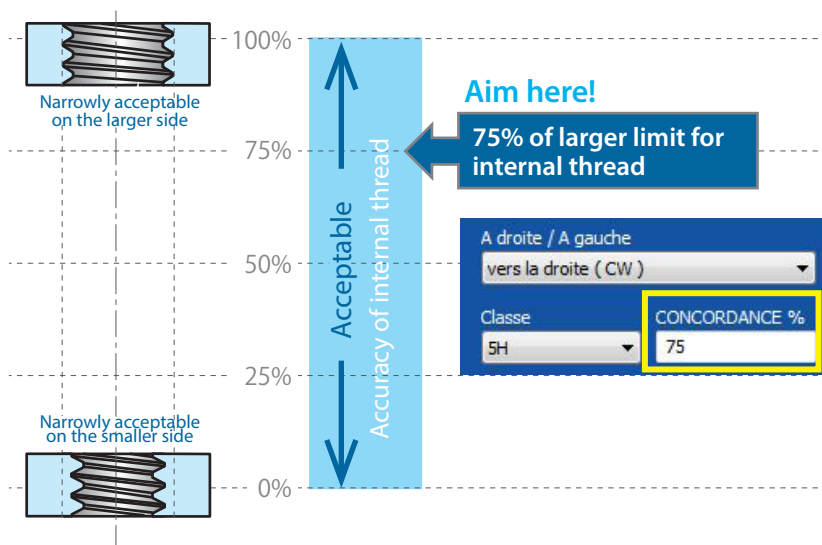

## Is ThreadPro compatible with NC programs developed for custom-made thread mills?

Yes, please consult our sales representatives.

# AT-1

Threading | Thread milling | Metric & Metric Fine

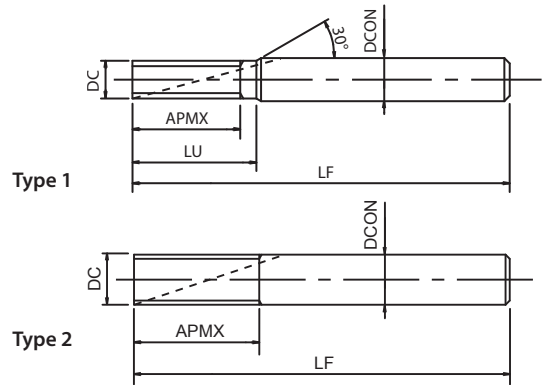
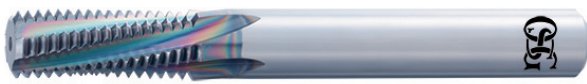

- First choice in quality and performance
- One pass thread mill
- EgiAs coating
- For all materials and hardened steels up to 45 HRC
- ThreadPro NC code generator software available

Threading | Thread milling

<b>P</b>	<b>P</b>	<b>P</b>	<b>P</b>	<b>M</b>	<b>K</b>	<b>K</b>	<b>N</b>	<b>N</b>	<b>H</b>	<b>H</b>	m/min
C < 0,2%	0,25 < C < 0,4	C ≥ 0,45%	SCM	INOX	GG	GGG	Al	AC, ADC	25-35 HRC	35-45 HRC	
80-160	80-160	80-160	60-120	60-120	80-160	60-120	80-160	100-300	80-200	80-200	

<b>A</b>	<b>M</b>	<b>MF</b>	<b>MJ</b>	<b>CARBIDE</b>	<b>EgiAs</b>	<b>9°~13°</b>	<b>h6</b>	<b>P.29</b>
----------	----------	-----------	-----------	----------------	--------------	---------------	-----------	-------------

Metric & Metric Fine

EDP	Minimum cutting bore diameter	TP	DC	LF	APMX	LU	DCON	NOF	Type
8331000	M6	0,75	4,5	75	13,5	16	6	4	1
8331001	M6	1	4,5	75	14	16	6	4	1
8331002	M8	0,5	5,7	75	17	-	6	4	2
8331003	M8	1	5,7	75	18	-	6	4	2
8331004	M8	1,25	5,7	75	18,75	-	6	4	2
8331005	M10	1	7,7	85	22	-	8	4	2
8331006	M10	1,25	7,7	85	22,5	-	8	4	2
8331007	M10	1,5	7,7	85	24	-	8	4	2
8331008	M12	1	9,7	100	26	-	10	5	2
8331009	M12	1,25	9,7	100	27,5	-	10	5	2
8331010	M12	1,5	9,7	100	27	-	10	5	2
8331011	M12	1,75	9,7	100	28	-	10	5	2
8331012	M14	0,5	11,7	120	29	-	12	5	2
8331013	M14	0,75	11,7	120	30	-	12	5	2
8331014	M14	1	11,7	120	30	-	12	5	2
8331015	M14	1,5	10,7	120	31,5	34,5	12	5	1
8331016	M14	2	9,7	100	32	-	10	5	2
8331017	M16	1	13,7	135	34	39	16	5	1
8331018	M16	1,5	13,7	135	36	39	16	5	1
8331019	M16	2	11,7	120	36	-	12	5	2
8331020	M18	2,5	11,7	120	42,5	-	12	5	2
8331021	M20	1,5	15,7	135	43,5	-	16	5	2
8331022	M20	2,5	13,7	135	45	50	16	5	1
8331023	M24	1,5	19,7	150	51	-	20	6	2
8331024	M24	2	19,7	150	52	-	20	6	2
8331025	M24	3	19,7	150	54	-	20	6	2

# WX-PNC

Threading | Thread milling | Metric & Metric Fine

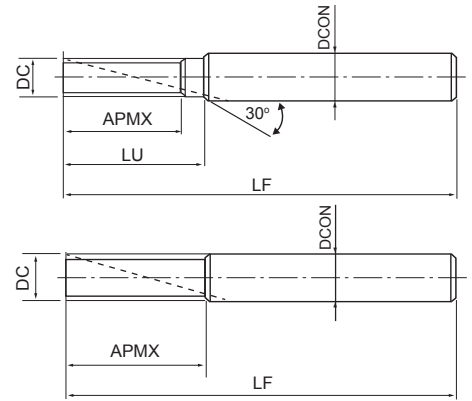

- Carbide thread milling cutter
- WX coating
- For all materials
- ThreadPro NC code generator software available

<b>P</b> ○ C < 0,2%	<b>P</b> ○ 0,25 < C < 0,4	<b>P</b> ○ C ≥ 0,45%	<b>P</b> ○ SCM	<b>M</b> ○ INOX	<b>K</b> ○ GG	<b>K</b> ○ GGG	<b>N</b> ○ Al	<b>N</b> ○ AC, ADC	<b>S</b> ● Ti	<b>S</b> ● Ni	<b>H</b> ○ 25-35 HRC	<b>H</b> ○ 35-45 HRC	m/min
50-75	50-75	40-70	15-30	20-40	50-100	50-65	50-70	65-130	20-60	20-60	15-30	15-30	

<b>M</b>	<b>MF</b>	<b>MJ</b>	<b>CARBIDE</b>	<b>WX</b>	<b>30°</b>	<b>h6</b>	<b>P.30</b>
----------	-----------	-----------	----------------	-----------	------------	-----------	-------------

EDP	Minimum cutting bore diameter	TP	DC	LF	APMX	LU	DCON	NOF	Type
3900001	M6	1	4,5	60	13	15	6	3	1
3900011	M8	1	6	65	17	-	6	3	2
3900012	M8	1,25	6	65	17,5	-	6	3	2
3900021	M10	1	7,5	70	21	26	8	3	1
1004470640	M10	1,25	7,5	70	21,3	26	8	3	1
3900023	M10	1,5	7,5	70	22,5	26	8	3	1
3900033	M12	1,5	9,5	85	25,5	28	10	4	1
3900032	M12	1,25	9,5	85	26,3	28	10	4	1
3900034	M12	1,75	9,5	85	26,3	28	10	4	1
3900042	M14	1	10	85	29	-	10	4	2
3900043	M14	1,5	10	85	30	-	10	4	2
3900044	M14	2	10	85	30	-	10	4	2
3900052	M16	1	12	95	33	-	12	4	2
3900054	M16	2	12	95	34	-	12	4	2
3900053	M16	1,5	12	95	34,5	-	12	4	2
3900073	M20	1,5	16	105	42	-	16	4	2
3900075	M20	2,5	16	105	42,5	-	16	4	2
3900083	M27	1,5	20	120	49,5	-	20	5	2
3900084	M27	2	20	120	50	-	20	5	2
3900086	M27	3	20	120	51	-	20	5	2

Threading | Thread milling

Metric & Metric Fine

# WXO-ST-PNC

Threading | Thread milling | Metric & Metric Fine

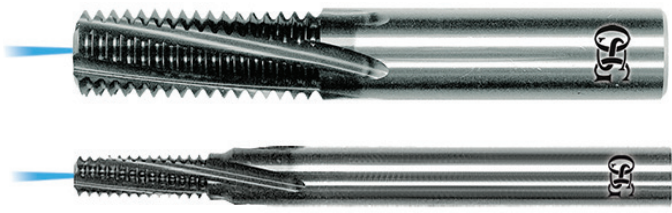

- Carbide thread milling cutter with centre through coolant
- WX coating
- For all materials and hardened steels up to 45 HRC
- ThreadPro NC code generator software available

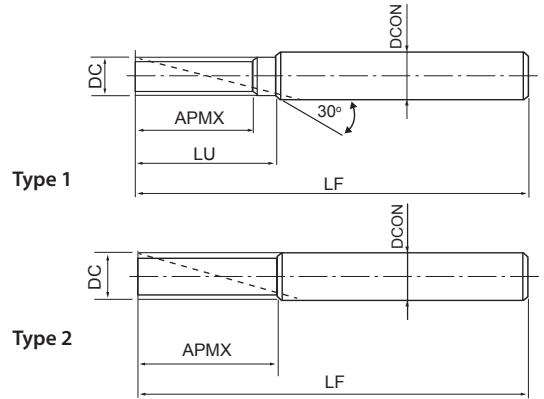

Threading | Thread milling

<b>P</b> ○ C < 0,2%	<b>P</b> ● 0,25 < C < 0,4	<b>P</b> ● C ≥ 0,45%	<b>P</b> ● SCM	<b>M</b> ○ INOX	<b>K</b> ○ GG	<b>K</b> ○ GGG	<b>N</b> ○ Al	<b>N</b> ○ AC, ADC	<b>H</b> ● 25-35 HRC	<b>H</b> ● 35-45 HRC	m/min
80-120	80-120	80-120	80-120	40-80	50-100	50-65	50-70	65-130	60-100	60-100	
<b>M</b>	<b>MF</b>	<b>MJ</b>	<b>CARBIDE</b>	<b>WX</b>	<b>11°</b>		<b>h6</b>				

Metric & Metric Fine

EDP	Minimum cutting bore diameter	TP	DC	LF	APMX	LU	DCON	NOF	Type
8304700	M6	0,75	4,5	60	12,8	15	6	4	1
8304701	M6	1	4,5	60	13	15	6	4	1
8304710	M8	0,5	6	65	16,5	-	6	4	2
8304711	M8	1	6	65	17	-	6	4	2
8304712	M8	1,25	6	65	17,5	-	6	4	2
8304721	M10	1	7,5	70	21	26	8	4	1
8304723	M10	1,5	7,5	70	22,5	26	8	4	1
8304732	M12	1,25	9,5	85	26,3	28	10	5	1
8304733	M12	1,5	9,5	85	25,5	28	10	5	1
8304734	M12	1,75	9,5	85	26,3	28	10	5	1
8304740	M14	0,5	10	85	28,5	-	10	5	2
8304741	M14	0,75	10	85	29,3	-	10	5	2
8304742	M14	1	10	85	29	-	10	5	2
8304743	M14	1,5	10	85	30	-	10	5	2
8304744	M14	2	10	85	30	-	10	5	2
8304752	M16	1	12	95	33	-	12	5	2
8304753	M16	1,5	12	95	34,5	-	12	5	2
8304754	M16	2	12	95	34	-	12	5	2
8304773	M20	1,5	16	105	42	-	16	5	2
8304775	M20	2,5	16	105	42,5	-	16	5	2
8304783	M27	1,5	20	120	49,5	-	20	6	2
8304784	M27	2	20	120	50	-	20	6	2
8304786	M27	3	20	120	51	-	20	6	2







# AT-1

Threading | Thread milling | UNC UNJC UNF UNJF

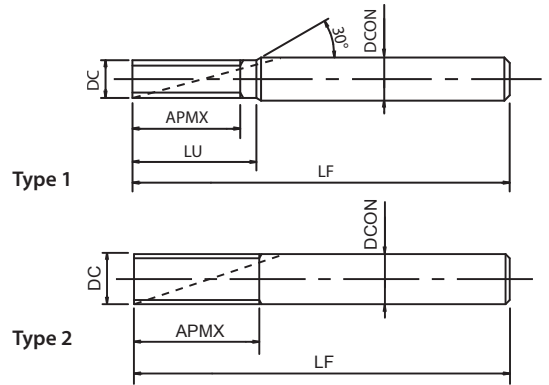

- First choice in quality and performance
- One pass thread mill
- EgiAs coating
- For all materials and hardened steels up to 45 HRC
- ThreadPro NC code generator software available

<b>P</b>	<b>P</b>	<b>P</b>	<b>P</b>	<b>M</b>	<b>K</b>	<b>K</b>	<b>N</b>	<b>N</b>	<b>H</b>	<b>H</b>	m/min
C < 0,2%	0,25 < C < 0,4	C ≥ 0,45%	SCM	INOX	GG	GGG	Al	AC, ADC	25-35 HRC	35-45 HRC	
80-160	80-160	80-160	60-120	60-120	80-160	60-120	80-160	100-300	80-200	80-200	

<b>A</b>	<b>UNC</b>	<b>UNJC</b>	<b>UNF</b>	<b>UNJF</b>	<b>CARBIDE</b>	<b>EgiAs</b>	<b>9°~13°</b>	<b>h6</b>	P.29
----------	------------	-------------	------------	-------------	----------------	--------------	---------------	-----------	------

EDP	Minimum cutting bore diameter	TP	DC	LF	APMX	LU	DCON	NOF	Type
8331026	UN1/4	20	4,55	75	15,24	17,78	6	4	1
8331027	UN1/4	28	4,55	75	15,42	17,23	6	4	1
8331028	UN5/16	18	5,7	75	19,75	-	6	4	2
8331029	UN5/16	24	5,7	75	19,04	-	6	4	2
8331030	UN5/16	32	5,7	75	17,47	-	6	4	2
8331031	UN3/8	16	6,7	85	22,23	25,41	8	4	1
8331032	UN3/8	24	6,7	85	22,22	24,33	8	4	1
8331033	UN3/8	32	6,7	85	20,64	22,23	8	4	1
8331034	UN7/16	14	7,7	85	27,21	-	8	4	2
8331035	UN7/16	20	7,7	85	25,4	-	8	4	2
8331036	UN1/2	13	8,7	100	29,31	33,22	10	5	1
8331037	UN1/2	20	8,7	100	27,94	30,48	10	5	1
8331038	UN1/2	28	8,7	100	28,12	29,93	10	5	1
8331039	UN9/16	12	9,7	100	33,87	-	10	5	2
8331040	UN9/16	18	9,7	100	32,45	-	10	5	2
8331041	UN5/8	11	10,7	120	36,94	41,56	12	5	1
8331042	UN5/8	18	10,7	120	35,28	38,1	12	5	1
8331043	UN5/8	24	10,7	120	34,91	37,03	12	5	1
8331044	UN3/4	10	11,7	120	43,18	-	12	5	2
8331045	UN3/4	16	11,7	120	41,29	-	12	5	2
8331046	UN7/8	9	13,7	135	50,8	56,44	16	5	1
8331047	UN7/8	14	13,7	135	48,98	52,61	16	5	1
8331048	UN1	8	18,7	150	57,15	63,5	20	6	1
8331049	UN1	20	18,7	150	53,34	55,88	20	6	1

Threading | Thread milling

UNC UNJC UNF UNJF





# AT-1

Threading | Thread milling | Rc (PT), R (PT)

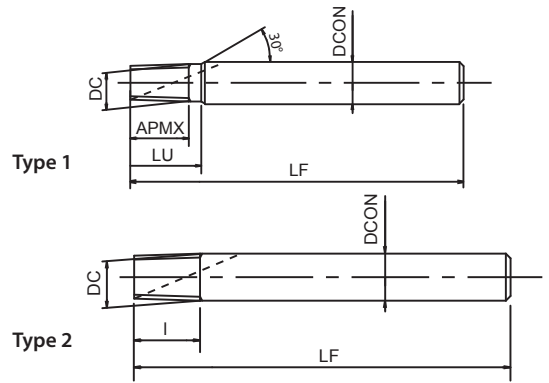
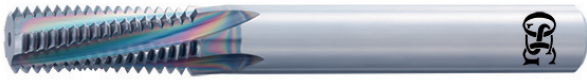

- First choice in quality and performance
- One pass thread mill
- EgiAs coating
- For all materials and hardened steels up to 45 HRC
- ThreadPro NC code generator software available

Threading | Thread milling

<b>P</b>	<b>P</b>	<b>P</b>	<b>P</b>	<b>M</b>	<b>K</b>	<b>K</b>	<b>N</b>	<b>N</b>	<b>H</b>	<b>H</b>	m/min
C < 0,2%	0,25 < C < 0,4	C ≥ 0,45%	SCM	INOX	GG	GGG	Al	AC, ADC	25-35 HRC	35-45 HRC	
80-160	80-160	80-160	60-120	60-120	80-160	60-120	80-160	100-300	80-200	80-200	

<b>A</b>	<b>Rc (PT)</b>	<b>R (PT)</b>	CARBIDE	EgiAs	9°~13°	h6
----------	----------------	---------------	---------	-------	--------	----



EDP	Minimum cutting bore diameter	TP	DC	LF	APMX	LU	DCON	NOF	Type
8331075	1/16	28	5,67	60	9,1	-	6	4	2
8331076	1/8	28	7,67	60	9,1	12,7	8	4	1
8331077	1/4-3/8	19	9,67	75	14,7	-	10	5	2
8331078	3/8	19	11,67	85	14,7	20	12	5	1
8331079	1/2-3/4	14	11,67	85	20	-	12	5	2
8331080	3/4	14	15,67	95	20	-	16	5	2
8331081	1-2	11	19,67	105	27,7	-	20	6	2

Rc (PT), R (PT)















# CUTTING CONDITIONS

Threading | Thread mills | Cutting conditions

## AT-1

Work Material		Vc (m/min)	F (mm/tooth)
Low Tensile Strength Steel	C~0,25%	80~160	0,01~0,05
Medium Tensile Strength Steel	C~0,25% ~ 0,45%	80~160	0,01~0,05
High Tensile Strength Steel	C0,45%~	80~160	0,01~0,05
Alloy Steel	SCM	60~120	0,01~0,05
Hardened Steel	25~45 HRC	80~200	0,01~0,05
	45~55 HRC	-	-
	50~60 HRC	-	-
Stainless Steel	SUS	60~120	0,01~0,05
Tool Steel	SKD	-	-
Cast Steel	SC	60~120	0,01~0,05
Cast Iron	FC	80~160	0,01~0,05
Ductile Cast Iron	FCD	60~120	0,01~0,05
Copper	Cu	80~160	0,03~0,1
Brass	Bs	80~160	0,03~0,1
Brass Casting	BsC	80~160	0,03~0,1
Bronze	PB	80~160	0,03~0,1
Aluminium Rolled Steel	AL	80~160	0,03~0,1
Aluminium Alloy Casting	AC, ADC	100~300	0,05~0,2
Magnesium Alloy Casting	MC	100~300	0,05~0,2
Zinc Alloy Casting	ZDC	100~300	0,05~0,2
Titanium Alloys	Ti-6AL-4V	-	-
Nickel Alloys	Inconel®	-	-
Thermosetting plastic	-	80~160	0,03~0,1
Thermoplastic	-	80~160	0,03~0,1

1. The indicated speeds and feeds are for water-soluble oil.
2. Water-soluble oil is not suitable for tapping magnesium alloy.
3. Please adjust the cutting conditions depending on the rigidity of machine, tool holders, and workpiece clamping.
4. If the tapping length is long, or when machining a large-pitch thread, select a smaller feed rate and separate the machining process into a few segments.
5. If a machined parallel internal thread is tapered and prevents the go-gauge from going through, add a zero cut (finish machining).

## Formula for calculating the feed rate of thread mill

$$V_f = \frac{f \times z \times n \times (D_m \pm D_c)}{D_m} \text{ (mm/min)}$$

$v_f$	Feed (mm/min)	$z$	Number of Flutes
$D_m$	Actual Dia. (mm)	$fz$	Feed (mm/t)
$D_c$	Tool Dia. (mm)	$n$	Speed (min <sup>-1</sup> )
Note Internal: -		External: +	

For the arc cutting process of machining external and internal threads, the feed rate at the tool center can be obtained by multiplying the linear cut feed rate with a coefficient. The formulas for calculating coefficients vary between external and internal thread cutting. The formula listed left are for calculating the tool feed rate during arc-cutting, including calculating the coefficients to be used for multiplication with the linear-cut feed rate.

# CUTTING CONDITIONS

Threading | Thread mills | Cutting conditions

## WXO-ST-PNC

Work Material		Vc (m/min)	F (mm/tooth)
Low Tensile Strength Steel	C~0,25%	80~120	0,04~0,1
Medium Tensile Strength Steel	C~0,25% ~ 0,45%	80~120	0,04~0,1
High Tensile Strength Steel	C0,45%~	80~120	0,04~0,1
Alloy Steel	SCM	80~120	0,02~0,08
Hardened Steel	25~45 HRC	60~100	0,02~0,08
	45~55 HRC	-	-
	50~60 HRC	-	-
Stainless Steel	SUS	40~80	0,02~0,06
Tool Steel	SKD	-	-
Cast Steel	SC	40~65	0,02~0,09
Cast Iron	FC	50~100	0,03~0,1
Ductile Cast Iron	FCD	50~65	0,03~0,1
Copper	Cu	65~130	0,03~0,1
Brass	Bs	65~130	0,03~0,1
Brass Casting	BsC	65~130	0,03~0,1
Bronze	PB	65~130	0,03~0,1
Aluminium Rolled Steel	AL	50~70	0,03~0,1
Aluminium Alloy Casting	AC, ADC	65~130	0,03~0,1
Magnesium Alloy Casting	MC	65~130	0,03~0,1
Zinc Alloy Casting	ZDC	65~130	0,03~0,1
Titanium Alloys	Ti-6AL-4V	20~60	0,02~0,06
Nickel Alloys	Inconel®	20~60	0,01~0,03
Thermosetting plastic	-	65~130	0,03~0,13
Thermoplastic	-	65~130	0,03~0,13

Threading | Thread milling

Cutting conditions

## WX-PNC

Work Material		Vc (m/min)	F (mm/tooth)
Low Tensile Strength Steel	C~0,25%	50~75	0,01~0,11
Medium Tensile Strength Steel	C~0,25% ~ 0,45%	40~70	0,01~0,11
High Tensile Strength Steel	C0,45%~	40~70	0,01~0,01
Alloy Steel	SCM	15~30	0,01~0,03
Hardened Steel	25~45 HRC	15~30	0,01~0,03
	45~55 HRC	-	-
	50~60 HRC	-	-
Stainless Steel	SUS	20~40	0,01~0,06
Tool Steel	SKD	-	-
Cast Steel	SC	40~65	0,02~0,09
Cast Iron	FC	50~100	0,03~0,1
Ductile Cast Iron	FCD	50~65	0,03~0,1
Copper	Cu	65~130	0,03~0,1
Brass	Bs	65~130	0,03~0,1
Brass Casting	BsC	65~130	0,03~0,1
Bronze	PB	65~130	0,03~0,1
Aluminium Rolled Steel	AL	50~70	0,03~0,1
Aluminium Alloy Casting	AC, ADC	65~130	0,03~0,1
Magnesium Alloy Casting	MC	65~130	0,03~0,1
Zinc Alloy Casting	ZDC	65~130	0,03~0,1
Titanium Alloys	Ti-6AL-4V	20~60	0,02~0,06
Nickel Alloys	Inconel®	20~60	0,01~0,03
Thermosetting plastic	-	65~130	0,03~0,13
Thermoplastic	-	65~130	0,03~0,13



# CUTTING CONDITIONS

Threading | Thread mills | Cutting conditions

## WH-VM-PNC/WX-ST-PNC-3P



Work Material		Vc (m/min)	F (mm/tooth)
Low Tensile Strength Steel	C~0,25%	60~90	0,02~0,08
Medium Tensile Strength Steel	C~0,25% ~ 0,45%	60~90	0,02~0,08
High Tensile Strength Steel	C0,45%~	60~90	0,02~0,08
Alloy Steel	SCM	30~60	0,01~0,03
Hardened Steel	25~45 HRC	30~60	0,01~0,03
	45~55 HRC	30~60	0,01~0,03
	50~60 HRC	-	-
Stainless Steel	SUS	60~90	0,02~0,08
Tool Steel	SKD	-	-
Cast Steel	SC	40~65	0,02~0,09
Cast Iron	FC	50~100	0,03~0,1
Ductile Cast Iron	FCD	50~70	0,03~0,1
Copper	Cu	-	-
Brass	Bs	-	-
Brass Casting	BsC	50~100	0,02~0,06
Bronze	PB	50~100	0,02~0,06
Aluminium Rolled Steel	AL	50~100	0,02~0,06
Aluminium Alloy Casting	AC, ADC	50~100	0,02~0,06
Magnesium Alloy Casting	MC	50~100	0,02~0,06
Zinc Alloy Casting	ZDC	50~100	0,02~0,06
Titanium Alloys	Ti-6AL-4V	20~60	0,01~0,03
Nickel Alloys	Inconel®	20~60	0,01~0,03
Thermosetting plastic	-	50~100	0,02~0,06
Thermoplastic	-	50~100	0,02~0,06



## Machining Technique

OSG's Thread Mills are developed for thread milling on a 3-Axis CNC controlled machine tool. Threads are produced by advancing one pitch feed per revolution in the axial direction, utilizing the planet-like rotation and revolution movements of the tool. Internal/external and right/left hand threads can all be produced with this one tool by simply changing the direction of rotation and/or feed

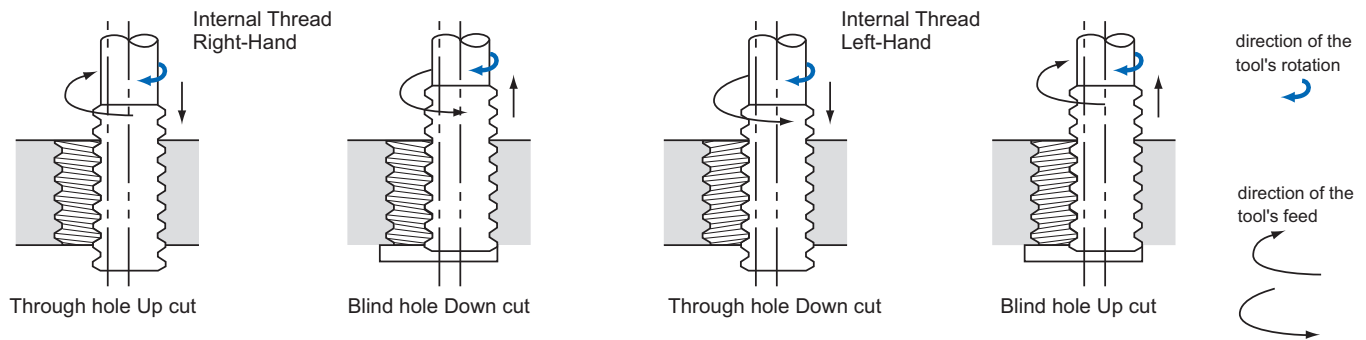

## Threading Process

- 1-2 Move to edge (maintain clearance)
- 2-3 Cut with helical milling
- 3-4 Mill the circumference of the circle
- 4-5 Pull away from the edge
- 5-6 Remove tool

The transition between the start and finish of the milling operation must be smooth and the appropriate amount of feed is essential for minimizing milling resistance. There are many different methods for using this tool, but our research has shown that this technique provides the most precise and efficient operation.

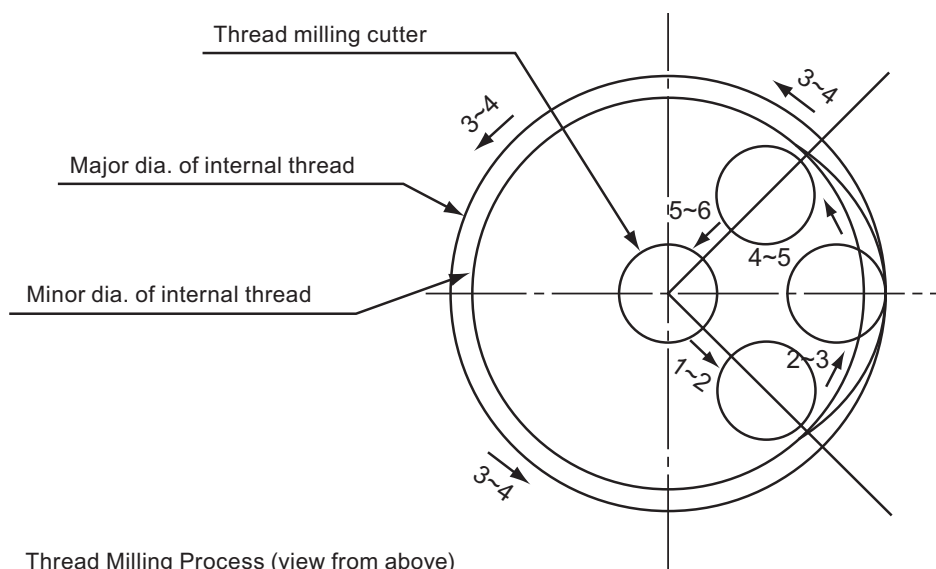

## Machining small diameter internal threads with stainless steel

Tool	WH-VM-PNC 0,72 P0,25	Competitor	Description	Tool Life	
	SUS304			100	200
Work Material	SUS304		WH-VM-PNC	212 Holes → Gauge-Out	
Cutting Speed	80m/min (35.367min <sup>-1</sup> )			235 Holes → Gauge-Out	
Feed	594mm/min (0.02mm/t)				
Internal Thread Size	M1x0.25				
Drill Hole Size	φ0.78x2.5mm (Blind)		Competitor	122 Holes → Gauge-Out	
Tapping Length	2mm (2D) (Blind)			198 Holes → Gauge-Out	
Machining Method	Up Cut 2 passes				
Coolant	Water Soluble				
Machine	(HSK-E25) Vertical Machining Center				

The WH-VM-PNC was able to perform stably with water-soluble coolant in stainless steel, a difficult process for cut taps. It was able to achieve long tool life and perform stably when tapping M1 threads. When processing threads with limited tap drill hole depth allowance for tap drill holes, the WH-VM-PNC was able to perform more stably than a conventional cut tap.

## Machining small diameter internal threads with Inconel 718

Tool	WH-VM-PNC 3,2 x 2,4 U32		Cutting Speed	N° of Passes	Number of Holes				
	Inconel 718 (40HRC)				20	40	60	80	
Work Material	Inconel 718 (40HRC)		40m/min	4	50 Holes → Substantial tool chipping				
Cutting Speed	40m/min (3.980min <sup>-1</sup> )	60m/min (5.970min <sup>-1</sup> )			60 Holes → Substantial tool chipping				
Feed	120mm/min (0,03mm/t)	180mm/min (0,03mm/t)		60m/min	2	40 Holes → Substantial tool chipping			
Internal Thread Size	N°10~32 UNF								
Drill Hole Size	φ4,1x14mm (Blind)								
Tapping Length	9mm (1,9D) (Blind)								
Machining Method	Down Cut 2-4 passes								
Coolant	Water Soluble								
Machine	(HSK-A40) Vertical Machining Center								

Compared to taps, thread mills have fewer cutting condition limitations. There are no worries about chip management or coolant lubricity, and stable tapping is possible. In this example, we were able to improve the yield rate of small diameter internal threads in a high value workpiece. Further durability improvements and cost reductions can be expected by adjusting the feed rate and number of passes, and changing the cutting fluid.

## Outstanding Performance in Stainless with Water-Soluble Coolant

Tool	WX-ST-PNC 7,5x9,1RC 28
Work Material	SUS304
Cutting Speed	130m/min (9.970min <sup>-1</sup> )
Feed	607mm/min (0,1mm/t)
Internal Thread Size	Rc 1/8-28
Drill Hole Size	φ8,2x9mm (Though)
Tapping Length	6,2 mm
Machining Method	Down Cut
Coolant	Water Soluble
Machine	Vertical Machining Center

Description	Number of Holes		
	500	1.000	1.500
WH-ST-PNC	1.315 Holes → Gauge-Out		
Competitor A	1.217 Holes → Gauge-Out		
Competitor B	1.000 Holes → Gauge-Out		

Tool life comparison against other competitors under identical cutting condition in SUS304. The tool life of the WX-ST-PNC was slightly higher than other competitors. Also, in terms of tool wear, it was the only tool that was in fair enough condition for regrinding.

### Tool Wear Amount

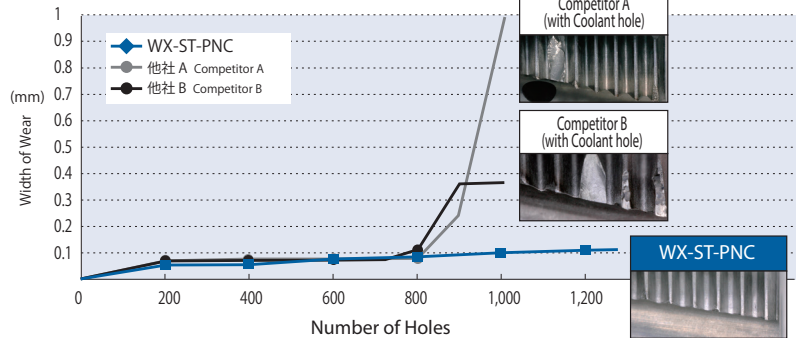

## Stable performance in S45C

Tool	WX-ST-PNC 7,5x9,1RC 28
Work Material	S45C
Cutting Speed	100m/min (4.592min <sup>-1</sup> )
Feed	327mm/min (0,07mm/t)
Internal Thread Size	Rc 1/8-28
Drill Hole Size	φ8,2x9mm (Though)
Tapping Length	6,2 mm
Machining Method	Down Cut
Coolant	Water Soluble
Machine	Vertical Machining Center (BT30)

### Pitch-dia. Reduced amount

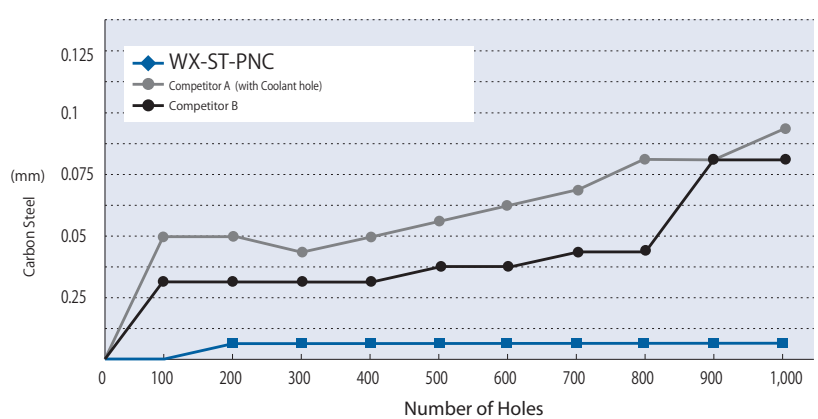

Cutting results in S45C. The WX-ST-PNC was able to stably process 1,000 holes with minimal changes in the effective diameter.

## Long tool life when high-speed machining hardened steels

<b>Tool</b>	<b>WXO-ST-PNC 9,5 x 26,3 P1,75</b>
<b>Work Material</b>	SCM440 (40HRC)
<b>Cutting Speed</b>	100m/min (3.351min <sup>-1</sup> )
<b>Feed</b>	349mm/min (0.1mm/t)
<b>Internal Thread Size</b>	M12x1,75
<b>Drill Hole Size</b>	φ10,3
<b>Tapping Length</b>	20 mm
<b>Machining Method</b>	Down Cut 2 passes
<b>Coolant</b>	Water Soluble (10%) (Internal)
<b>Machine</b>	Vertical Machining Center

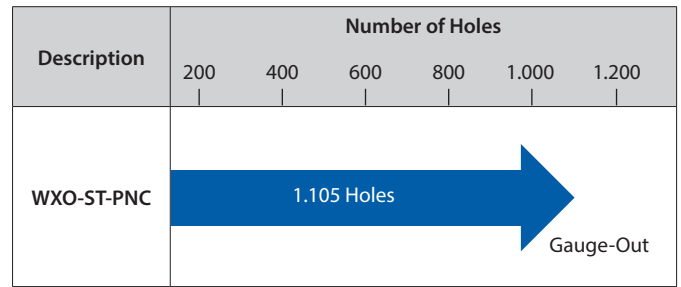

Machined continuously without making tool diameter corrections.

In this example, even when high-speed machining at 100m/min with internally supplied coolant, there was no chipping and long tool life was achieved. The internal threads' pitch diameter measurement was stable, demonstrating the effectiveness of this tool in mass production machining.

Pitch diameter of internal thread

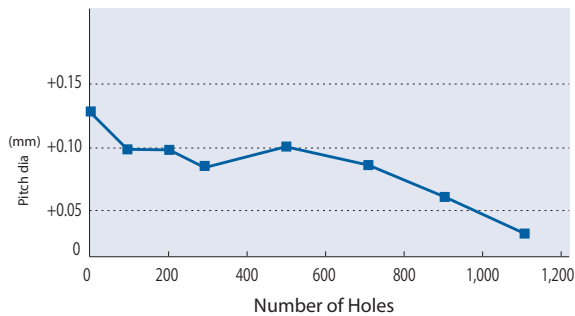

Changes in the extent of wear on the outer circumference

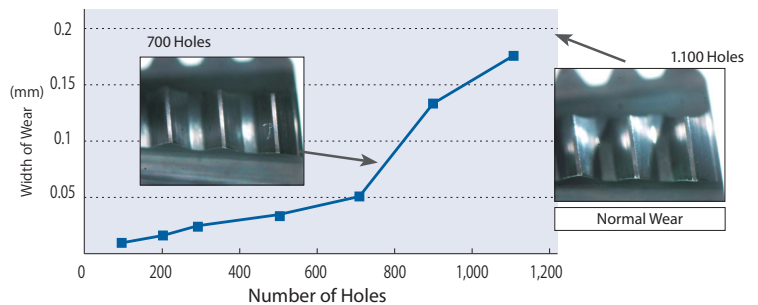

## Stable machining in stainless steels, Wear is 40% less than the competitor

<b>Tool</b>	<b>WXO-ST-PNC 9,5 x 26,6 P1,75</b>
<b>Work Material</b>	SUS 304
<b>Cutting Speed</b>	80m/min (2.681min <sup>-1</sup> )
<b>Feed</b>	168mm/min (0,06 mm/t)
<b>Internal Thread Size</b>	M12x1,75
<b>Tapping Length</b>	23 mm
<b>Coolant</b>	Water Soluble
<b>Machine</b>	Vertical Machining Center (BT40)

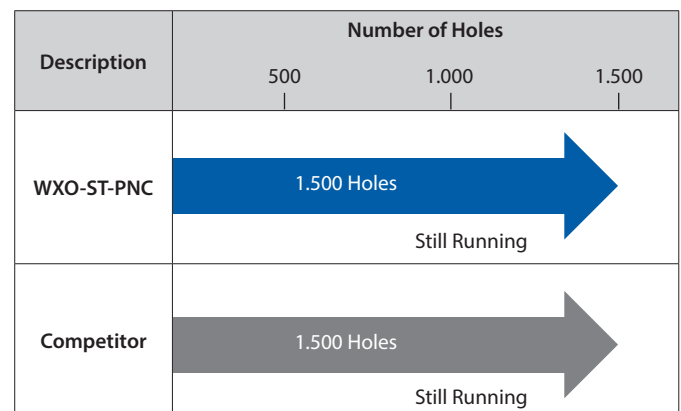

Even when machining stainless steel at 80m/min, it was possible to machine over 1,500 holes, and tool wear was 40% less than the competitor's product. Low wear, slow wear progression and long, stable machining of internal threads were achieved.

Changes in the extent of wear on the outer circumference

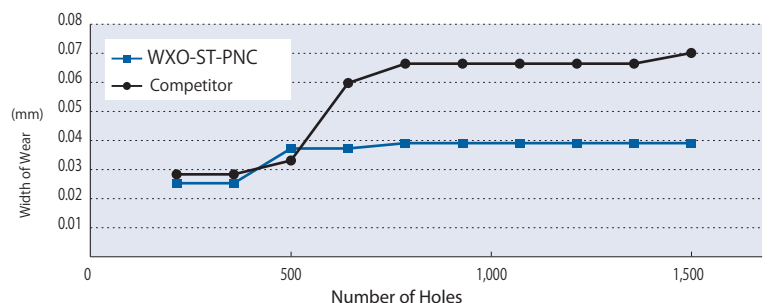

## In non-ferrous materials, WX-PNC has excellent durability

Tool	WX-PNC 7,6 x 14,3 U16	Number of Holes			
Description		2.000	4.000	6.000	8.000
Work Material	A7075				
Cutting Speed	160m/min (6.701min <sup>-1</sup> )				
Feed	650mm/min (0,16 mm/t)				
Internal Thread Size	3/8-16				
Tapping Length	12 mm				
Coolant	Water Soluble				
Machine	Vertical Machining Center (BT40)				

Even after machining 8,800 holes in A7075 with a cutting speed of 160m/min, tool wear was negligible. It was still possible for the WX-PNC to continue much more, effectively achieving stable machining of internal threads on a machining center.



No.1 (after cutting 8,800 threads)

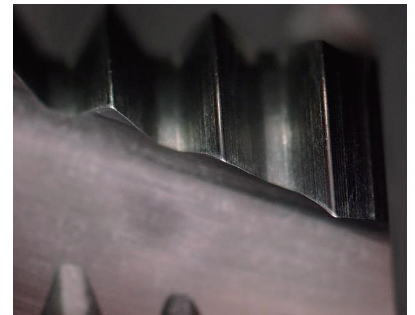

No.2 (after cutting 8,800 threads)

## The WX-PNC is also for heat-resistant steels. It achieved twice the tool life of the competitor in Inconel 718

Tool	WX-PNC 4,55 x 10,8 U20
Work Material	Inconel 718 (43HRC)
Internal Thread Size	1/4-20 UNC
Tapping Length	9 mm
Feed per Tooth	0,03 mm/t
Coolant	Water Soluble (10%)
Machine	Horizontal Machining Center

### Cutting Speed and Durability Count

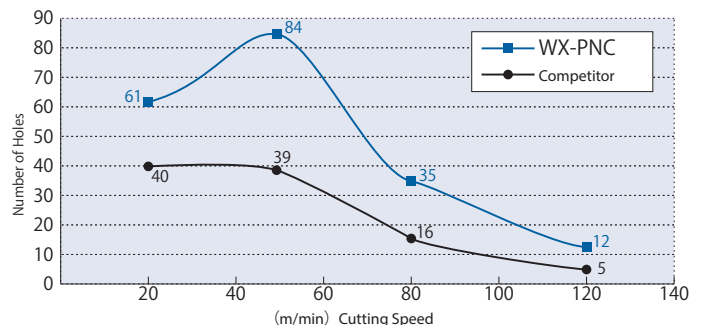

These are the test results in Inconel® 718 at various cutting speeds. At cutting speeds under 50m/min, durability is better and this seems to be an effective machining range. The WX-PNC achieves twice the tool life of the competitor, no matter the cutting speed.



# FEEDBACK FROM THREADPRO USERS

*"An increased variety of NC machines to select from has helped me a lot." (User)*

*"The RPRG is very convenient! Before RPRG, I set the depth of cut on a trial-and-error basis for the first session. Now I can confidently set the depth correctly the first time." (User)*

*"I have no trouble selecting a tool, although it has been difficult for me to find the right combination of a holder and an insert . (Distributor)*

*"It is very convenient and easy to select the type of the tool or cutting edge according to the cutting context." (User)*

*"The search results show relevant tool profiles and dimensions, for which I am glad." (User)*

## VOICE OF THREADPRO DEVELOPER

In recent years, various theories concerning cutting have been proposed for end milling, considering load control and cutting efficiency. This is due to higher flexibility in end milling than in tapping. Thread mill is a thread cutting tool. However, as cutting methods it is closer to end mills than taps. Accordingly, to achieve optimal thread milling, parameters should include the cutting path as well as other cutting conditions. Nevertheless, because the workings of a thread mill are inherently complex, it is very difficult for the user to achieve the proper arrangement. OSG has radically updated the NC program development software to enable users to realize their ideas with increased ease and make more effective use of their tools than before.

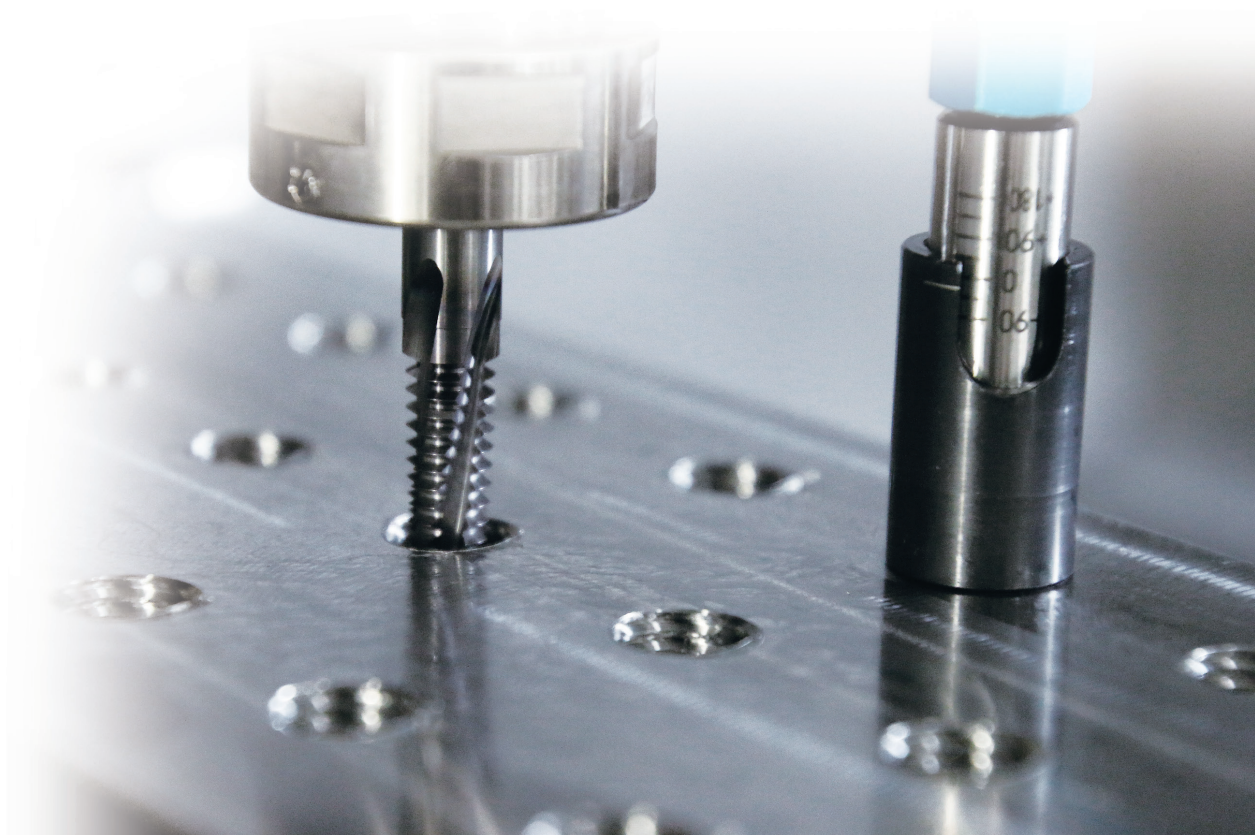

# KEY FEATURES: AT-2

Helical drilling + threading can be done simultaneously !





# AT-2: THREAD MILL WITH END-CUTTING EDGE FOR HIGH HARDNESS STEELS

**No pilot hole is required!**  
**Stable machining without chip trouble**

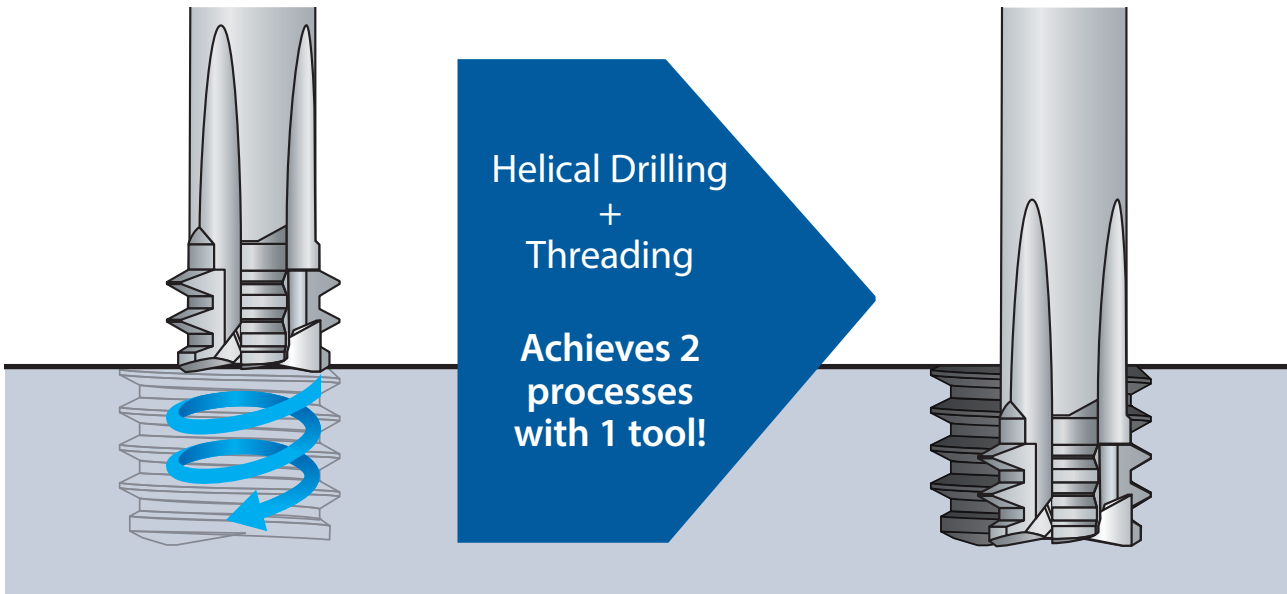

Threading | Thread milling

## 3 Supportive Tools for Your Thread Milling Needs

- 1 ThreadPro**  
Creates programs easily  
Thread Milling NC Code Generator Software

### Web ThreadPro

AT-2 is supported by Web version only  
Web version of ThreadPro is now available

- 2 RPRG**  
Reduces correction works  
Reference value of tool radius offset

- 3 DCT**  
Stabilizes tool life  
Diameter Correction Tool

# AT-2 NEW SIZES

Threading | Thread milling | Metric



Type 1

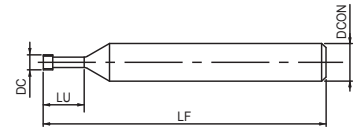

Type 2

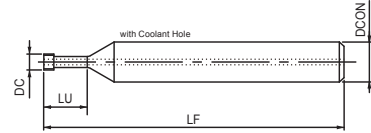

- First choice in quality and performance
- Thread milling without pre-drilled hole
- DUROREY coating
- For hardened steels up to 65 HRC and stainless steels
- ThreadPro NC code generator software available

Threading | Thread milling

<b>P</b> ○ C < 0,2%	<b>P</b> ○ 0,25 < C < 0,4	<b>P</b> ○ C ≥ 0,45%	<b>P</b> ○ SCM	<b>M</b> ○ INOX	<b>K</b> ○ GG	<b>K</b> ○ GGG	<b>N</b> ○ Al	<b>N</b> ○ AC, ADC	<b>S</b> ● Ti	<b>S</b> ● Ni	<b>H</b> ● 25-45 HRC	<b>H</b> ● 45-55 HRC	<b>H</b> ● ~65 HRC	
35-55	80-160	80-160	60-120	35-100	35-100	35-100	35-100	35-100	35-55	35-55	35-75	35-65	35-55	m/min
0,01~0,07	0,01~0,07	0,01~0,07	0,01~0,07	0,01~0,07	0,01~0,07	0,01~0,07	0,01~0,07	0,01~0,07	0,01~0,07	0,01~0,07	0,01~0,07	0,01~0,07	0,01~0,07	mm/t
<b>A</b>	<b>M</b>	<b>CARBIDE</b>	<b>DUROREY</b>		<b>h6</b>	<b>LH</b>								 P.50

Metric

EDP	Minimum cutting bore diameter	Maximum cutting bore diameter	TP	DC	LF	LU	DCON	NOF	Type
8331200	M3	4,2	0,5	2,4	50	7,2	6	4	1
8331207	M3	4,2	0,5	2,4	50	8,7	6	4	1
8331201	M4	5,3	0,7	3,1	50	9,7	6	4	1
8331208	M4	5,3	0,7	3,1	50	11,7	6	4	1
8331202	M5	7	0,8	4	50	12	6	4	1
8331209	M5	7	0,8	4	50	14,5	6	4	1
8331203	M6	8	1	4,6	50	14,5	6	4	1
8331210	M6	8	1	4,6	50	17,5	6	4	1
8331204	M8	10,9	1,25	6,2	70	19,1	10	4	1
8331211	M8	10,9	1,25	6,2	70	23,1	10	4	1
8331205	M10	13,2	1,5	7,5	70	23,7	10	4	2
8331212	M10	13,2	1,5	7,5	70	28,7	10	4	2
8331206	M12	15,9	1,75	9	80	28,3	10	4	2
8331213	M12	15,9	1,75	9	80	34,3	10	4	2
8331240	M16	21,1	2	11,7	100	37	12	4	2
8331243 <small>NEW</small>	M16	21,1	2	11,7	100	45	12	4	2
8331241 <small>NEW</small>	M18	25,1	2,5	14	135	42,2	16	4	2
8331244 <small>NEW</small>	M18	25,1	2,5	14	135	51,2	16	4	2
8331242 <small>NEW</small>	M20	28,5	2,5	15,7	135	46,2	16	4	2
8331245 <small>NEW</small>	M20	28,5	2,5	15,7	135	56,2	16	4	2







# CUTTING DATA

The standard outer diameter (DC) of the tapered pipe type represents the dimension of the outer diameter of the central cutting edge.

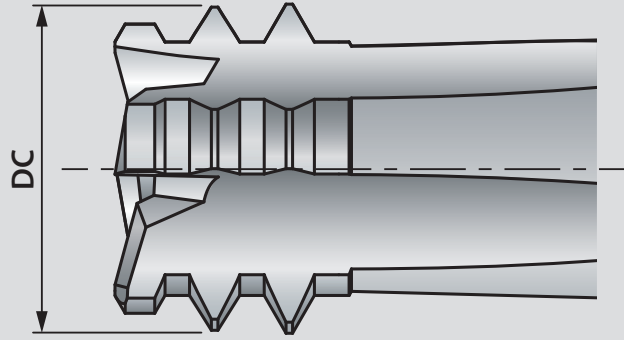

## Thread mills are ideal for machining tapered pipe threads

High-precision threading can be achieved with no stop marks and high roundness

Stop Marks

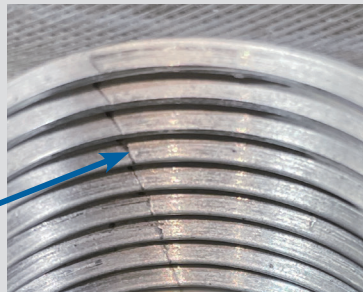

Processing by tap



Processing by thread mill

Capable of processing even shallower tapered threads than tapered pipe taps

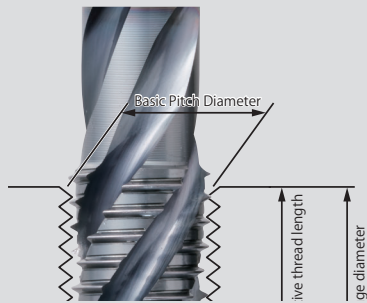

Processing by tap

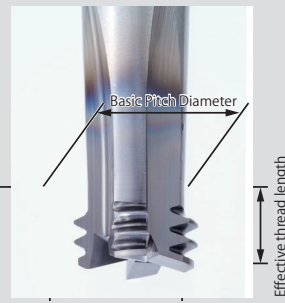

Processing by thread mill

Even if the drill hole is shallow and the tap cannot be inserted to the gauge diameter position, a thread mill can process tapered threads that are shallower than the short thread standard by specifying the thread length through programming.

# AT-2: IDEAL FOR HIGHLY DIFFICULT HIGH HARDNESS STEEL APPLICATIONS!

**Helical drilling + threading can be done simultaneously, which reduces the risk of potential machining problems in the processing of high hardness steels**

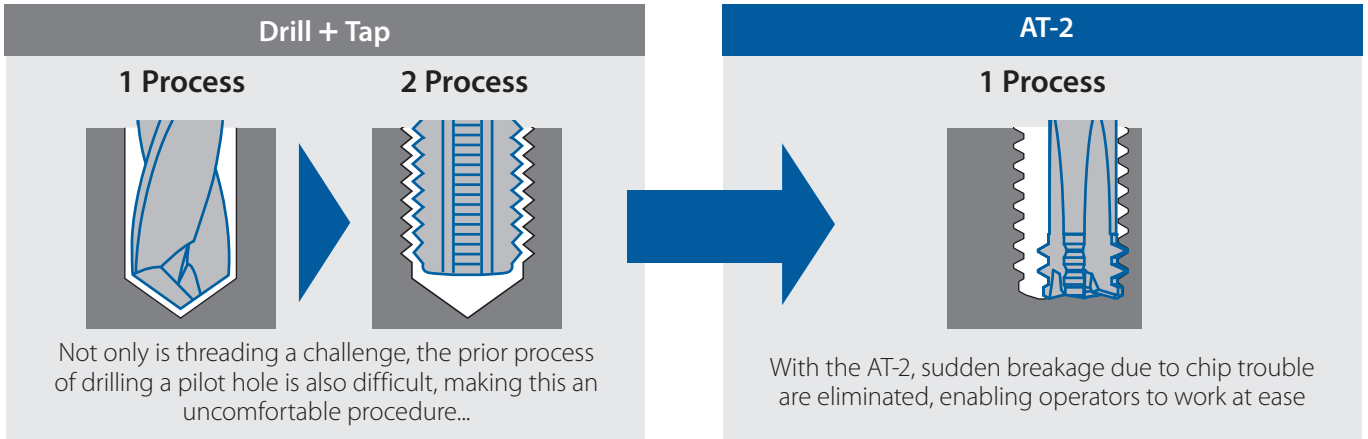

The risk of sudden tool breakage can be minimized by breaking chips into small and manageable pieces and evacuating them smoothly. Since no pilot hole is required, process integration and the risk of breakage can be avoided.

**Long and stable tool life with higher thread quality compared to cutting taps**

<b>Tool</b>	AT-2 Ø6,2 x 16 P1,25	Carbide hand tap for high hardness steels M8x1,25 3P
<b>Work Material</b>	SKD11 (60HRC)	
<b>Cutting Speed</b>	45m/min (2.310min <sup>-1</sup> )	2m/min (80min <sup>-1</sup> )
<b>Feed</b>	83mm/min(0,04m-t)	100mm/min
<b>Drill Hole Size</b>	None	Ø6,8 x 23,5mm (Blind)
<b>Internal Thread size</b>	M8x1,25	
<b>Threading Length</b>	16mm (2D)	
<b>Coolant</b>	Air Blow	Non-Water-Soluble
<b>Machine</b>	Horizontal Machining Center	Vertical Machining Center

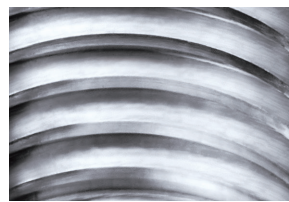
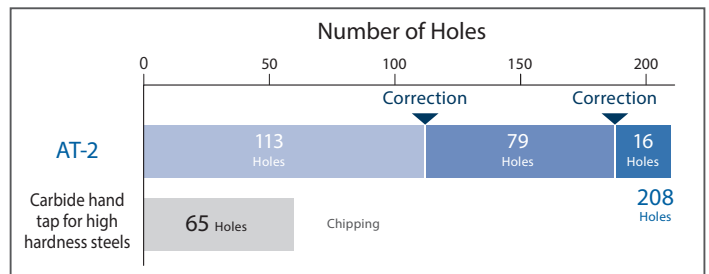

## DUROREY

Newly developed DUROREY coating enables superior heat resistance and high toughness optimized for high-hardness steel milling!

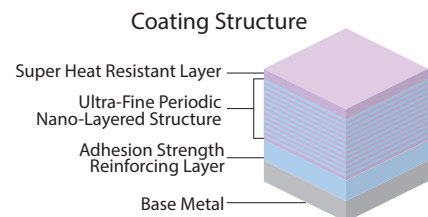

Super heat resistant layer and ultra-fine periodic nano-layered structure provide superior toughness while maintaining high heat resistance and abrasion resistance. Also suppresses chipping even in high hardness milling and achieves long tool life.

Coating Color	Coating Structure	(GPa) Hardness	(C°) Oxidation Temperature	Heat Resistance	Adhesion Strength	Surface Roughness	Wear Resistance	Welding Resistance	Toughness
Black Gray	Ultra-Fine Periodic Nano-Layered	41	1.300	☆	◎	○	☆	◎	◎



## Evaluation method of cutting test

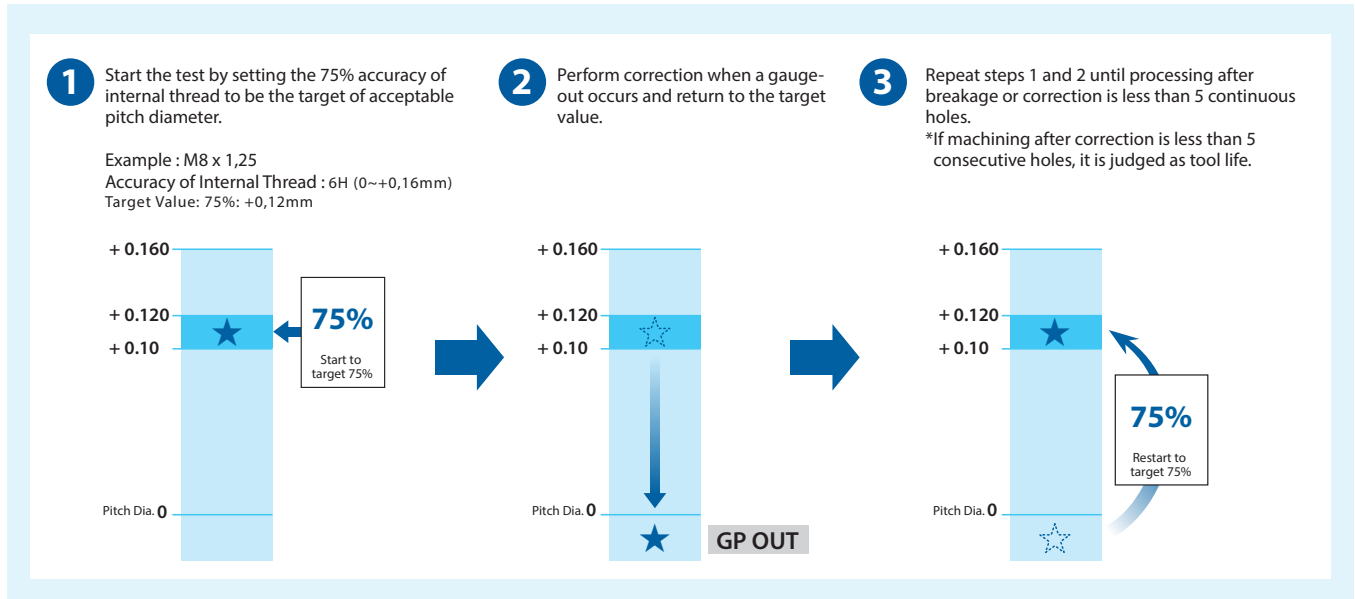

## Outstanding durability by cutting with air-blow

Size	Ø3,1 × 8 P0,7	Ø6,2 × 16 P1,25	Ø7,5 × 20 P1,5
Work Material	SKD11 (60 HRC)		
Cutting Speed	45 m/min (4.621min <sup>-1</sup> )	45 m/min (2.310min <sup>-1</sup> )	35 m/min (1.485min <sup>-1</sup> )
Feed	46 mm/min (0,011mm/t)	83 mm/min (0,04mm/t)	56 mm/min (0,038mm/t)
Internal Thread Size	M4 x 0,7	M8 x 1,25	M10 x 1,25
Threading Length	7 mm	14,8 mm	18,5 mm
Coolant	Air Blow		
Machine	(BT40) Horizontal Machining Center	(HSK63) Vertical Machining Center	

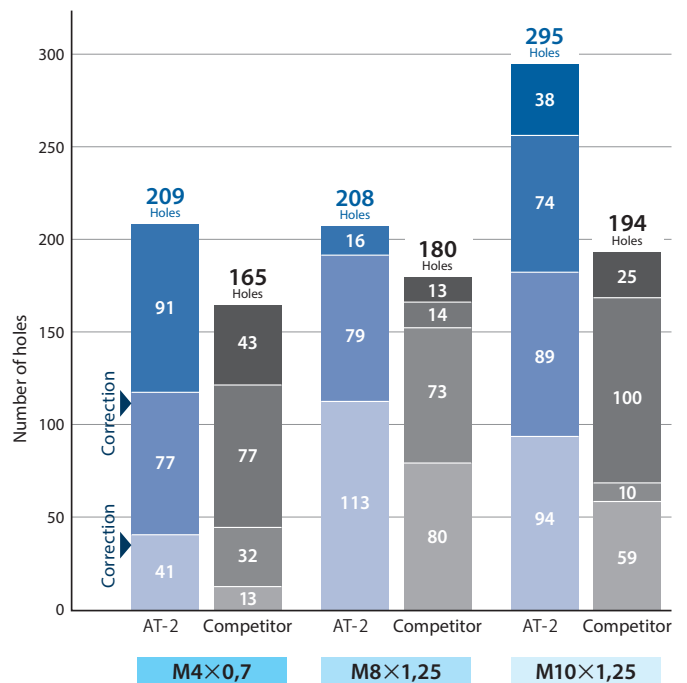



## Stable durability with water-soluble coolant

Size	Ø4 × 10 P0,8	Ø7,5 × 20 P1,5
Work Material	SKD11 (60 HRC)	
Cutting Speed	45 m/min (3.581min <sup>-1</sup> )	45 m/min (1.910min <sup>-1</sup> )
Feed	66 mm/min (0,023mm/t)	73 mm/min (0,038mm/t)
Internal Thread Size	M5 x 0,8	M10 x 1,25
Threading Length	9,2 mm	18,5 mm
Coolant	Water-Soluble	
Machine	(BT40) Horizontal Machining Center	(HSK63) Vertical Machining Center

Unlike processing with cutting taps, which often involves the use of non-water-soluble coolant, water-soluble coolant can be used with the AT-2, reducing the need to replace machines.

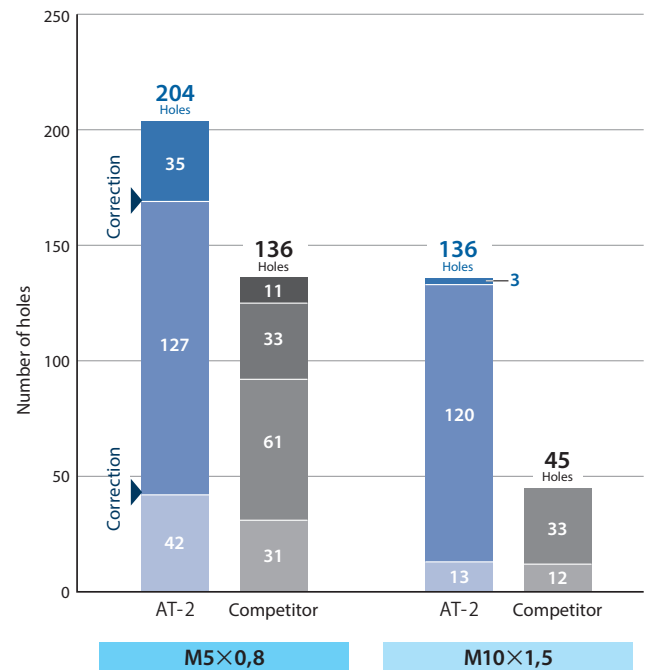

## Stable threading of 2,5 x D made possible

Tool	AT-2 Ø7,5x25 P1,5
Work Material	SKD11 (60 HRC)
Cutting Speed	35 m/min (1.485min <sup>-1</sup> )
Feed	56 mm/min (0,038mm/t)
Internal Thread Size	M10 x 1,5
Threading Length	22,5 mm
Coolant	Air Blow
Machine	(HSK63) Vertical Machining Center

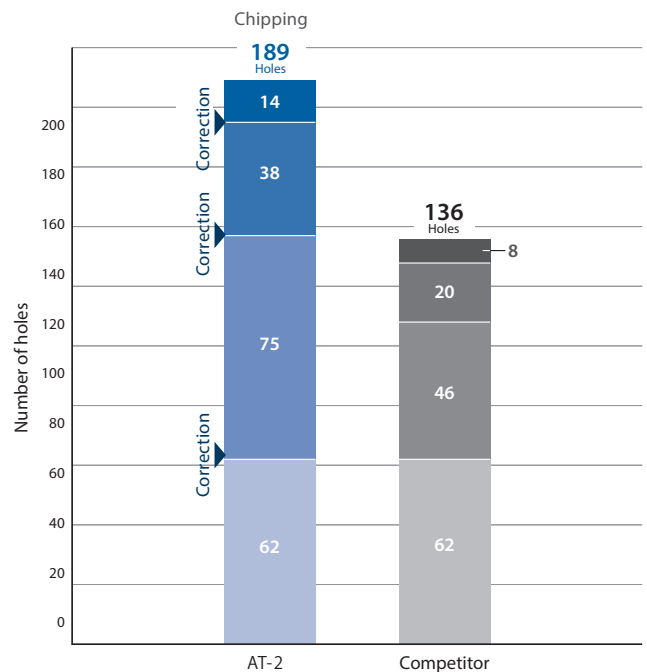

# CUTTING DATA

## Remarkable durability in 65 HRC work material

Tool	AT-2 Ø4 × 10 P0,8
Work Material	(60 HRC) Equivalent to SKH
Cutting Speed	45 m/min (3.581 min <sup>-1</sup> )
Feed	29 mm/min (0,01mm/t)
Internal Thread Size	M5 x 0,8
Threading Length	8 mm (2D)
Coolant	Air Blow
Machine	Horizontal Machining Center

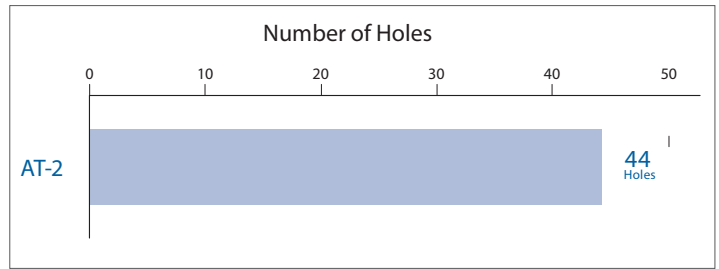

## Stable processing is made possible even in tapered pipe threads of 60 HRC

Tool	AT-2 Ø5,76 × 16,8 Rc28
Work Material	SKD11 (60HRC)
Cutting Speed	45 m/min (2.512 min <sup>-1</sup> )
Feed	39 mm/min (0,01mm/t)
Internal Thread Size	Rc 1/8-28
Threading Length	6,2 mm
Coolant	Air Blow
Machine	Vertical Machining Center (BT40)

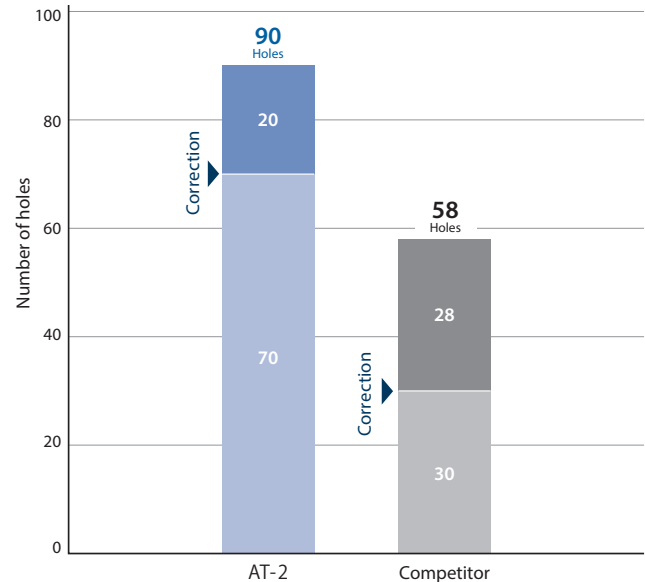

## Processing of tapered pipe threads in general steel

Tool	AT-2 Ø5,76 × 16,8 Rc28		
Work Material	STAVAX (50HRC)	NAK80 (40HRC)	S45C
Cutting Speed	45 m/min (2.512 min <sup>-1</sup> )		
Feed	39 mm/min (0,01mm/t)		
Internal Thread Size	Rc 1/8-28		
Threading Length	6,2 mm		
Coolant	Air Blow		
Machine	Vertical Machining Center (BT40)		

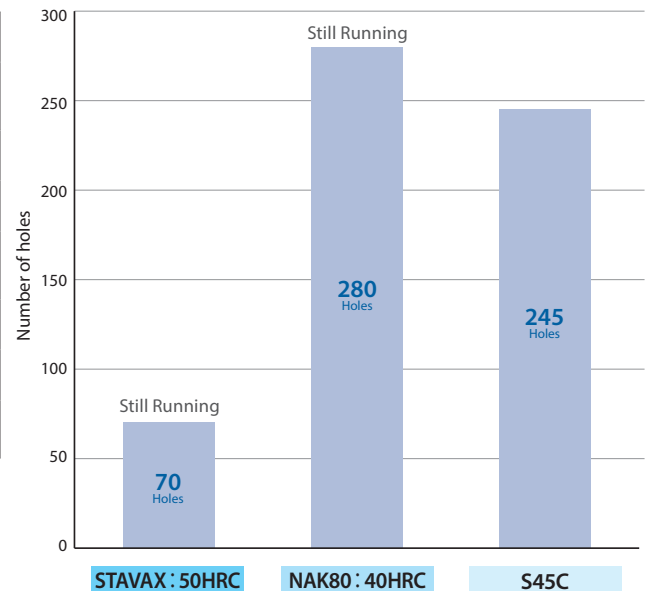

## Excellent durability even in STAVAX (around 50 HRC)

Tool	AT-2 Ø7,5x20 P1,5	
Work Material	STAVAX (53 HRC)	SKD (50 HRC)
Cutting Speed	55 m/min (2.331min <sup>-1</sup> )	
Feed	89 mm/min (0,038mm/t)	
Internal Thread Size	M10 X 1,5	
Threading Length	18 mm	
Coolant	Air Blow	
Machine	(BT40) Horizontal Machining Center	

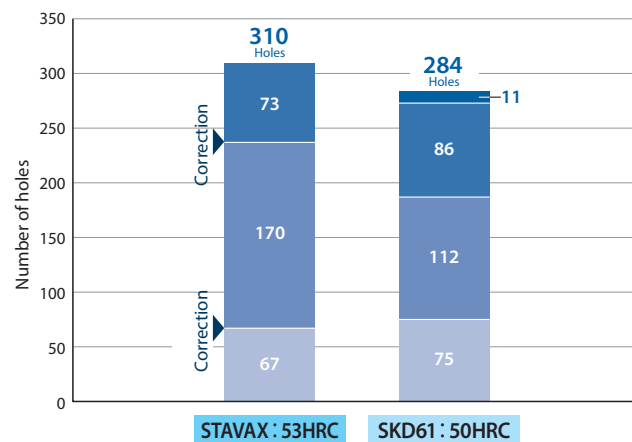

## Stable performance even in general steels

Tool	AT-2 Ø3,1x8 P0,7	
Work Material	SS400	S50C
Cutting Speed	45 m/min (4.621min <sup>-1</sup> )	85 m/min (8.728min <sup>-1</sup> )
Feed	46 mm/min (0,011mm/t)	86 mm/min (0,011mm/t)
Internal Thread Size	M4 X 0,7	
Threading Length	7 mm (2D)	
Coolant	Water-Soluble	
Machine	Vertical Machining Center	

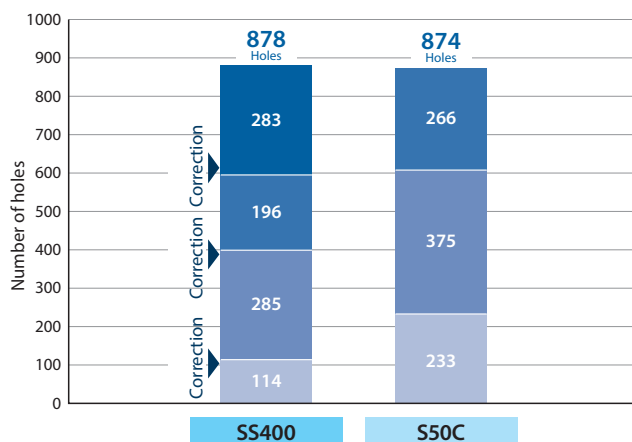

Since there is no cutting chip trouble, it is effective for avoiding the risk of tool breakage. Processing consolidation is also made possible.

Please refer to the following table to select a suitable coolant for cutting.

Work Material	AT-2	
	Air Blow	Water-Soluble
High-hardness steel	⊙	△
General steel	×	⊙

⊙ : Best  
 △ : Shortening of tool life  
 × : Not recommended

Water-soluble cutting fluids can be used with satisfactory result, although in some cases the durability is inferior to air-blow.



# CUTTING CONDITIONS

Threading | Thread milling | Cutting conditions

## AT-2



			Low Carbon Steel - Mild Steel ~C0,25%			Medium Carbon Steel - High Carbon Steel ~C0,25%			Alloy Steel SCM		
Recommended Coolant			Water-Soluble			Water-Soluble			Water-Soluble		
Vc (m/min)			35 ~ 55			80 ~ 160			60 ~ 120		
Thread	Thread Size	DC	Speed (min <sup>-1</sup> )	Feed (mm/min)	Feed per Tooth (mm/t)	Speed (min <sup>-1</sup> )	Feed (mm/min)	Feed per Tooth (mm/t)	Speed (min <sup>-1</sup> )	Feed (mm/min)	Feed per Tooth (mm/t)
M	M 3 x0,5	2,4	5.968	48	0,01	10.610	85	0,01	7.958	64	0,01
	M 4 x0,7	3,1	4.621	62	0,015	8.214	111	0,015	6.161	83	0,015
	M 5 x0,8	4	3.581	49	0,017	6.366	87	0,017	4.775	65	0,017
	M 6 x1	4,6	3.114	58	0,02	5.536	103	0,02	4.152	78	0,02
	M 8 x1,25	6,2	2.310	62	0,03	4.107	111	0,03	3.080	83	0,03
	M 10 x1,5	7,5	1.910	67	0,035	3.395	119	0,035	2.546	89	0,035
	M 12 x1,75	9	1.592	72	0,045	2.829	127	0,045	2.122	95	0,045
	M 16 x2	11,7	1.224	72	0,055	2.176	129	0,055	1.632	96	0,055
	M 18 x2,5	14	1.023	55	0,06	1.819	97	0,06	1.364	73	0,06
	M 20 x2,5	15,7	912	51	0,065	1.622	91	0,065	1.216	68	0,065
U	No. 8 - 32UNC	3,1	4.621	47	0,01	8.214	84	0,01	6.161	63	0,01
	No. 10 - 24UNC	3,7	3.871	54	0,015	6.882	96	0,015	5.162	72	0,015
	1/4 - 20UNC	4,55	3.148	89	0,025	5.597	159	0,025	4.197	119	0,025
	1/4 - 28UNF	4,55	3.148	89	0,025	5.597	159	0,025	4.197	119	0,025
	5/16 - 18UNC	5,7	2.513	85	0,03	4.468	151	0,03	3.351	113	0,03
	3/8 - 16UNC	6,7	2.138	89	0,035	3.801	158	0,035	2.851	118	0,035
	7/16 - 14UNC	7,7	1.860	91	0,04	3.307	162	0,04	2.480	122	0,04
	1/2 - 13UNC	9,2	1.557	77	0,045	2.768	137	0,045	2.076	103	0,045
	1/16 - 28	4,86	2.982	*1	0,025	5.302	*1	0,025	3.976	*1	0,025
	1/8 - 28	5,76	2.512	*1	0,03	4.465	*1	0,03	3.349	*1	0,03
Rc (PT)	1/4 - 19	7,98	1.814	*1	0,04	3.225	*1	0,04	2.419	*1	0,04
	3/8 - 19	9,68	1.493	*1	0,045	2.654	*1	0,045	1.990	*1	0,045
	1/2 - 14	11,61	1.246	*1	0,055	2.215	*1	0,055	1.661	*1	0,055
	1 - 11	15,54	930	*1	0,065	1.654	*1	0,065	1.240	*1	0,065
	1/16 - 27	4,86	2.984	*1	0,025	5.304	*1	0,025	3.978	*1	0,025
NPT	1/8 - 27	5,76	2.513	*1	0,03	4.467	*1	0,03	3.350	*1	0,03
	1/4 - 18	7,98	1.815	*1	0,04	3.227	*1	0,04	2.420	*1	0,04
	3/8 - 18	9,68	1.493	*1	0,045	2.655	*1	0,045	1.991	*1	0,045
	1/2 - 14	11,61	1.246	*1	0,055	2.215	*1	0,055	1.661	*1	0,055
	1 - 11 1/2	15,54	930	*1	0,065	1.653	*1	0,065	1.240	*1	0,065

Threading | Thread milling



			Hardened Steel								
			25~45 HRC			45~50 HRC			50~65 HRC		
Recommended Coolant			Air-Blow								
Vc (m/min)			35 ~ 75			35 ~ 65			35 ~ 55		
Thread	Thread Size	DC	Speed (min <sup>-1</sup> )	Feed (mm/min)	Feed per Tooth (mm/t)	Speed (min <sup>-1</sup> )	Feed (mm/min)	Feed per Tooth (mm/t)	Speed (min <sup>-1</sup> )	Feed (mm/min)	Feed per Tooth (mm/t)
M	M 3 x0,5	2,4	5.968	48	0,01	5.968	48	0,01	5.968	48	0,01
	M 4 x0,7	3,1	4.621	62	0,015	4.621	62	0,015	4.621	62	0,015
	M 5 x0,8	4	3.581	49	0,017	3.581	49	0,017	3.581	49	0,017
	M 6 x1	4,6	3.114	58	0,02	3.114	58	0,02	3.114	58	0,02
	M 8 x1,25	6,2	2.310	62	0,03	2.310	62	0,03	2.310	62	0,03
	M 10 x1,5	7,5	1.910	67	0,035	1.910	67	0,035	1.910	67	0,035
	M 12 x1,75	9	1.592	72	0,045	1.592	72	0,045	1.592	72	0,045
	M 16 x2	11,7	1.224	72	0,055	1.224	72	0,055	1.224	72	0,055
	M 18 x2,5	14	1.023	55	0,06	1.023	55	0,06	1.023	55	0,06
	M 20 x2,5	15,7	912	51	0,065	912	51	0,065	912	51	0,065
U	No. 8 - 32UNC	3,1	4.621	47	0,01	4.621	47	0,01	4.621	47	0,01
	No. 10 - 24UNC	3,7	3.871	54	0,015	3.871	54	0,015	3.871	54	0,015
	1/4 - 20UNC	4,55	3.148	89	0,025	3.148	89	0,025	3.148	89	0,025
	1/4 - 28UNF	4,55	3.148	89	0,025	3.148	89	0,025	3.148	89	0,025
	5/16 - 18UNC	5,7	2.513	85	0,03	2.513	85	0,03	2.513	85	0,03
	3/8 - 16UNC	6,7	2.138	89	0,035	2.138	89	0,035	2.138	89	0,035
	7/16 - 14UNC	7,7	1.860	91	0,04	1.860	91	0,04	1.860	91	0,04
	1/2 - 13UNC	9,2	1.557	77	0,045	1.557	77	0,045	1.557	77	0,045
	1/16 - 28	4,86	2.982	*1	0,025	2.982	*1	0,025	2.982	*1	0,025
	1/8 - 28	5,76	2.512	*1	0,03	2.512	*1	0,03	2.512	*1	0,03
Rc (PT)	1/4 - 19	7,98	1.814	*1	0,04	1.814	*1	0,04	1.814	*1	0,04
	3/8 - 19	9,68	1.493	*1	0,045	1.493	*1	0,045	1.493	*1	0,045
	1/2 - 14	11,61	1.246	*1	0,055	1.246	*1	0,055	1.246	*1	0,055
	1 - 11	15,54	930	*1	0,065	930	*1	0,065	930	*1	0,065
	1/16 - 27	4,86	2.984	*1	0,025	2.984	*1	0,025	2.984	*1	0,025
NPT	1/8 - 27	5,76	2.513	*1	0,03	2.513	*1	0,03	2.513	*1	0,03
	1/4 - 18	7,98	1.815	*1	0,04	1.815	*1	0,04	1.815	*1	0,04
	3/8 - 18	9,68	1.493	*1	0,045	1.493	*1	0,045	1.493	*1	0,045
	1/2 - 14	11,61	1.246	*1	0,055	1.246	*1	0,055	1.246	*1	0,055
	1 - 11 1/2	15,54	930	*1	0,065	930	*1	0,065	930	*1	0,065

\* Values vary depending on the depth of hole to be machined.

- 1, This cutting condition table shows standard values, When machining, it is recommended to use the program created by the NC code generator software ThreadPro,
- 2, Please adjust the cutting conditions depending on the rigidity of machine, tool holders, and workpiece clamping,
- 3, Tool vibrations should be kept at a minimum level for maximum accuracy,
- 4, When machining magnesium alloy materials, please use the coolant oil recommended by the coolant oil manufacturer, Please also properly dispose the cutting chips to prevent fire hazards,
- 5, Spindle rotation must be counterclockwise due to the left-hand cut configuration,

# CUTTING CONDITIONS

Threading | Thread milling | Cutting conditions

## AT-2

			Stainless Steel - Tool Steel SUS304 - SKD			Cast Steel - Cast Iron - Ductile Cast Iron SC - FC - FCD			Copper - Brass - Brass Casting - Bronze Cu - Bs - BsC - PB					
			Water-Soluble			Air-Blow			~20HRC			20HRC~		
Recommended Coolant			Water-Soluble			Air-Blow			Water-Soluble					
Vc (m/min)			35 ~ 100			35 ~ 100			35 ~ 100			35 ~ 75		
Thread	Thread Size	DC	Speed (min <sup>-1</sup> )	Feed (mm/min)	Feed per Tooth (mm/t)	Speed (min <sup>-1</sup> )	Feed (mm/min)	Feed per Tooth (mm/t)	Speed (min <sup>-1</sup> )	Feed (mm/min)	Feed per Tooth (mm/t)	Speed (min <sup>-1</sup> )	Feed (mm/min)	Feed per Tooth (mm/t)
M	M 3 × 0,5	2,4	5.968	48	0,01	7.958	64	0,01	7.958	64	0,01	5.968	48	0,01
	M 4 × 0,7	3,1	4.621	62	0,015	6.161	83	0,015	6.161	83	0,015	4.621	62	0,015
	M 5 × 0,8	4	3.581	49	0,017	4.775	65	0,017	4.775	65	0,017	3.581	49	0,017
	M 6 × 1	4,6	3.114	58	0,02	4.152	78	0,02	4.152	78	0,02	3.114	58	0,02
	M 8 × 1,25	6,2	2.310	62	0,03	3.080	83	0,03	3.080	83	0,03	2.310	62	0,03
	M 10 × 1,5	7,5	1.910	67	0,035	2.546	89	0,035	2.546	89	0,035	1.910	67	0,035
	M 12 × 1,75	9	1.592	72	0,045	2.122	95	0,045	2.122	95	0,045	1.592	72	0,045
	M 16 × 2	11,7	1.224	72	0,055	1.632	96	0,055	1.632	96	0,055	1.224	72	0,055
	M 18 × 2,5	14	1.023	55	0,06	1.364	73	0,06	1.364	73	0,06	1.023	55	0,06
M 20 × 2,5	15,7	912	51	0,065	1.216	68	0,065	1.216	68	0,065	912	51	0,065	
U	No. 8 - 32UNC	3,1	4.621	47	0,01	6.161	63	0,01	6.161	63	0,01	4.621	47	0,01
	No. 10 - 24UNC	3,7	3.871	54	0,015	5.162	72	0,015	5.162	72	0,015	3.871	54	0,015
	1/4 - 20UNC	4,55	3.148	89	0,025	4.197	119	0,025	4.197	119	0,025	3.148	89	0,025
	1/4 - 28UNF	4,55	3.148	89	0,025	4.197	119	0,025	4.197	119	0,025	3.148	89	0,025
	5/16 - 18UNC	5,7	2.513	85	0,03	3.351	113	0,03	3.351	113	0,03	2.513	85	0,03
	3/8 - 16UNC	6,7	2.138	89	0,035	2.851	118	0,035	2.851	118	0,035	2.138	89	0,035
	7/16 - 14UNC	7,7	1.860	91	0,04	2.480	122	0,04	2.480	122	0,04	1.860	91	0,04
	1/2 - 13UNC	9,2	1.557	77	0,045	2.076	103	0,045	2.076	103	0,045	1.557	77	0,045
	1/16 - 28	4,86	2.982	*1	0,025	3.976	*1	0,025	3.976	*1	0,025	2.982	*1	0,025
Rc (PT)	1/8 - 28	5,76	2.512	*1	0,03	3.349	*1	0,03	3.349	*1	0,03	2.512	*1	0,03
	1/4 - 19	7,98	1.814	*1	0,04	2.419	*1	0,04	2.419	*1	0,04	1.814	*1	0,04
	3/8 - 19	9,68	1.493	*1	0,045	1.990	*1	0,045	1.990	*1	0,045	1.493	*1	0,045
	1/2 - 14	11,61	1.246	*1	0,055	1.661	*1	0,055	1.661	*1	0,055	1.246	*1	0,055
	1 - 11	15,54	930	*1	0,065	1.240	*1	0,065	1.240	*1	0,065	930	*1	0,065
	1/16 - 27	4,86	2.984	*1	0,025	3.978	*1	0,025	3.978	*1	0,025	2.984	*1	0,025
	1/8 - 27	5,76	2.513	*1	0,03	3.350	*1	0,03	3.350	*1	0,03	2.513	*1	0,03
	1/4 - 18	7,98	1.815	*1	0,04	2.420	*1	0,04	2.420	*1	0,04	1.815	*1	0,04
	3/8 - 18	9,68	1.493	*1	0,045	1.991	*1	0,045	1.991	*1	0,045	1.493	*1	0,045
NPT	1/2 - 14	11,61	1.246	*1	0,055	1.661	*1	0,055	1.661	*1	0,055	1.246	*1	0,055
	1 - 11 1/2	15,54	930	*1	0,065	1.240	*1	0,065	1.240	*1	0,065	930	*1	0,065

			Aluminum Rolled Steel - Aluminum Alloy Casting AL - AC _ ADC			Magnesium Alloy Casting - Zinc Alloy Casting MC - ZDC			Titanium Alloy Ti-6Al-4V		
			Water-Soluble			Water-Soluble			Water-Soluble		
Vc (m/min)			35 ~ 100			35 ~ 100			35 ~ 55		
Thread	Thread Size	DC	Speed (min <sup>-1</sup> )	Feed (mm/min)	Feed per Tooth (mm/t)	Speed (min <sup>-1</sup> )	Feed (mm/min)	Feed per Tooth (mm/t)	Speed (min <sup>-1</sup> )	Feed (mm/min)	Feed per Tooth (mm/t)
M	M 3 × 0,5	2,4	10.610	85	0,01	7.958	64	0,01	5.968	48	0,01
	M 4 × 0,7	3,1	8.214	111	0,015	6.161	83	0,015	4.621	62	0,015
	M 5 × 0,8	4	6.366	87	0,017	4.775	65	0,017	3.581	49	0,017
	M 6 × 1	4,6	5.536	103	0,02	4.152	78	0,02	3.114	58	0,02
	M 8 × 1,25	6,2	4.107	111	0,03	3.080	83	0,03	2.310	62	0,03
	M 10 × 1,5	7,5	3.395	119	0,035	2.546	89	0,035	1.910	67	0,035
	M 12 × 1,75	9	2.829	127	0,045	2.122	95	0,045	1.592	72	0,045
	M 16 × 2	11,7	2.176	129	0,055	1.632	96	0,055	1.224	72	0,055
	M 18 × 2,5	14	1.819	97	0,06	1.364	73	0,06	1.023	55	0,06
M 20 × 2,5	15,7	1.622	91	0,065	1.216	68	0,065	912	51	0,065	
U	No. 8 - 32UNC	3,1	8.214	84	0,01	6.161	63	0,01	4.621	47	0,01
	No. 10 - 24UNC	3,7	6.882	96	0,015	5.162	72	0,015	3.871	54	0,015
	1/4 - 20UNC	4,55	5.597	159	0,025	4.197	119	0,025	3.148	89	0,025
	1/4 - 28UNF	4,55	5.597	159	0,025	4.197	119	0,025	3.148	89	0,025
	5/16 - 18UNC	5,7	4.468	151	0,03	3.351	113	0,03	2.513	85	0,03
	3/8 - 16UNC	6,7	3.801	158	0,035	2.851	118	0,035	2.138	89	0,035
	7/16 - 14UNC	7,7	3.307	162	0,04	2.480	122	0,04	1.860	91	0,04
	1/2 - 13UNC	9,2	2.768	137	0,045	2.076	103	0,045	1.557	77	0,045
	1/16 - 28	4,86	5.302	*1	0,025	3.976	*1	0,025	2.982	*1	0,025
Rc (PT)	1/8 - 28	5,76	4.465	*1	0,03	3.349	*1	0,03	2.512	*1	0,03
	1/4 - 19	7,98	3.225	*1	0,04	2.419	*1	0,04	1.814	*1	0,04
	3/8 - 19	9,68	2.654	*1	0,045	1.990	*1	0,045	1.493	*1	0,045
	1/2 - 14	11,61	2.215	*1	0,055	1.661	*1	0,055	1.246	*1	0,055
	1 - 11	15,54	1.654	*1	0,065	1.240	*1	0,065	930	*1	0,065
	1/16 - 27	4,86	5.304	*1	0,025	3.978	*1	0,025	2.984	*1	0,025
	1/8 - 27	5,76	4.467	*1	0,03	3.350	*1	0,03	2.513	*1	0,03
	1/4 - 18	7,98	3.227	*1	0,04	2.420	*1	0,04	1.815	*1	0,04
	3/8 - 18	9,68	2.655	*1	0,045	1.991	*1	0,045	1.493	*1	0,045
NPT	1/2 - 14	11,61	2.215	*1	0,055	1.661	*1	0,055	1.246	*1	0,055
	1 - 11 1/2	15,54	1.653	*1	0,065	1.240	*1	0,065	930	*1	0,065

\*1. Values vary depending on the depth of hole to be machined.

1. This cutting condition table shows standard values. When machining, it is recommended to use the program created by the NC code generator software ThreadPro.
2. Please adjust the cutting conditions depending on the rigidity of machine, tool holders, and workpiece clamping.
3. Tool vibrations should be kept at a minimum level for maximum accuracy.
4. When machining magnesium alloy materials, please use the coolant oil recommended by the coolant oil manufacturer. Please also properly dispose the cutting chips to prevent fire hazards.
5. Spindle rotation must be counterclockwise due to the left-hand cut configuration.

\* For titanium alloys and Ni-based alloys, the above condition table applies only when using a water-soluble cutting fluid and processing with a thread length approximately 1xD or an oil hole compatible size (oil hole column: ○ mark).



# CUTTING CONDITIONS

Threading | Thread milling | Cutting conditions

## AT-2



			Ni-based Alloy - Inconel			Plastic		
Recommended Coolant			Water-Soluble			Water-Soluble		
Vc (m/min)			35 ~ 55			35 ~ 100		
Thread	Thread Size	DC	Speed (min <sup>-1</sup> )	Feed (mm/min)	Feed per Tooth (mm/t)	Speed (min <sup>-1</sup> )	Feed (mm/min)	Feed per Tooth (mm/t)
M	M 3 x0,5	2,4	4.642	37	0,01	7.958	64	0,01
	M 4 x0,7	3,1	3.594	49	0,015	6.161	83	0,015
	M 5 x0,8	4	2.785	38	0,017	4.775	65	0,017
	M 6 x1	4,6	2.422	45	0,02	4.152	78	0,02
	M 8 x1,25	6,2	1.797	49	0,03	3.080	83	0,03
	M 10 x1,5	7,5	1.485	52	0,035	2.546	89	0,035
	M 12 x1,75	9	1.238	56	0,045	2.122	95	0,045
	M 16 x2	11,7	952	56	0,055	1.632	96	0,055
	M 18 x2,5	14	796	42	0,06	1.364	73	0,06
	M 20 x2,5	15,7	710	40	0,065	1.216	68	0,065
U	No, 8 - 32UNC	3,1	3.594	37	0,01	6.161	63	0,01
	No, 10 - 24UNC	3,7	3.011	42	0,015	5.162	72	0,015
	1/4 - 20UNC	4,55	2.449	69	0,025	4.197	119	0,025
	1/4 - 28UNF	4,55	2.449	69	0,025	4.197	119	0,025
	5/16 - 18UNC	5,7	1.955	66	0,03	3.351	113	0,03
	3/8 - 16UNC	6,7	1.663	69	0,035	2.851	118	0,035
	7/16 - 14UNC	7,7	1.447	71	0,04	2.480	122	0,04
	1/2 - 13UNC	9,2	1.211	60	0,045	2.076	103	0,045
	1/16 - 28	4,86	2.320	*1	0,025	3.976	*1	0,025
	1/8 - 28	5,76	1.954	*1	0,03	3.349	*1	0,03
RC (PT)	1/4 - 19	7,98	1.411	*1	0,04	2.419	*1	0,04
	3/8 - 19	9,68	1.161	*1	0,045	1.990	*1	0,045
	1/2 - 14	11,61	969	*1	0,055	1.661	*1	0,055
	1 - 11	15,54	724	*1	0,065	1.240	*1	0,065
NPT	1/16 - 27	4,86	2.321	*1	0,025	3.978	*1	0,025
	1/8 - 27	5,76	1.954	*1	0,03	3.350	*1	0,03
	1/4 - 18	7,98	1.412	*1	0,04	2.420	*1	0,04
	3/8 - 18	9,68	1.161	*1	0,045	1.991	*1	0,045
	1/2 - 14	11,61	969	*1	0,055	1.661	*1	0,055
	1 - 11 1/2	15,54	723	*1	0,065	1.240	*1	0,065

\*1. Values vary depending on the depth of hole to be machined.

- This cutting condition table shows standard values. When machining, it is recommended to use the program created by the NC code generator software ThreadPro.
- Please adjust the cutting conditions depending on the rigidity of machine, tool holders, and workpiece clamping.
- Tool vibrations should be kept at a minimum level for maximum accuracy.
- When machining magnesium alloy materials, please use the coolant oil recommended by the coolant oil manufacturer. Please also properly dispose the cutting chips to prevent fire hazards.
- Spindle rotation must be counterclockwise due to the left-hand cut configuration.

\* For titanium alloys and Ni-based alloys, the above condition table applies only when using a water-soluble cutting fluid and processing with a thread length approximately 1xD or an oil hole compatible size (oil hole column: ◯ mark).

## Formula for calculating the feed rate of thread mill

$$V_f = \frac{f_z \times z \times n \times (D_m - D_c)}{D_m} \text{ (mm/min)}$$

$v_f$	Feed (mm/min)	$z$	Number of Flutes
$D_m$	Actual Dia. (mm)	$f_z$	Feed (mm/t)
$D_c$	Tool Dia. (mm)	$n$	Speed (min <sup>-1</sup> )
Note Internal: -		External: +	

For the arc cutting process of machining external and internal threads, the feed rate at the tool center can be obtained by multiplying the linear cut feed rate with a coefficient. The formulas for calculating coefficients vary between external and internal thread cutting. The formula listed left are for calculating the tool feed rate during arc-cutting, including calculating the coefficients to be used for multiplication with the linear-cut feed rate.

# PROPER USAGE OF COOLANT

**When using external coolant, ensure that the cutting fluid is properly positioned so that it is supplied into the hole.**

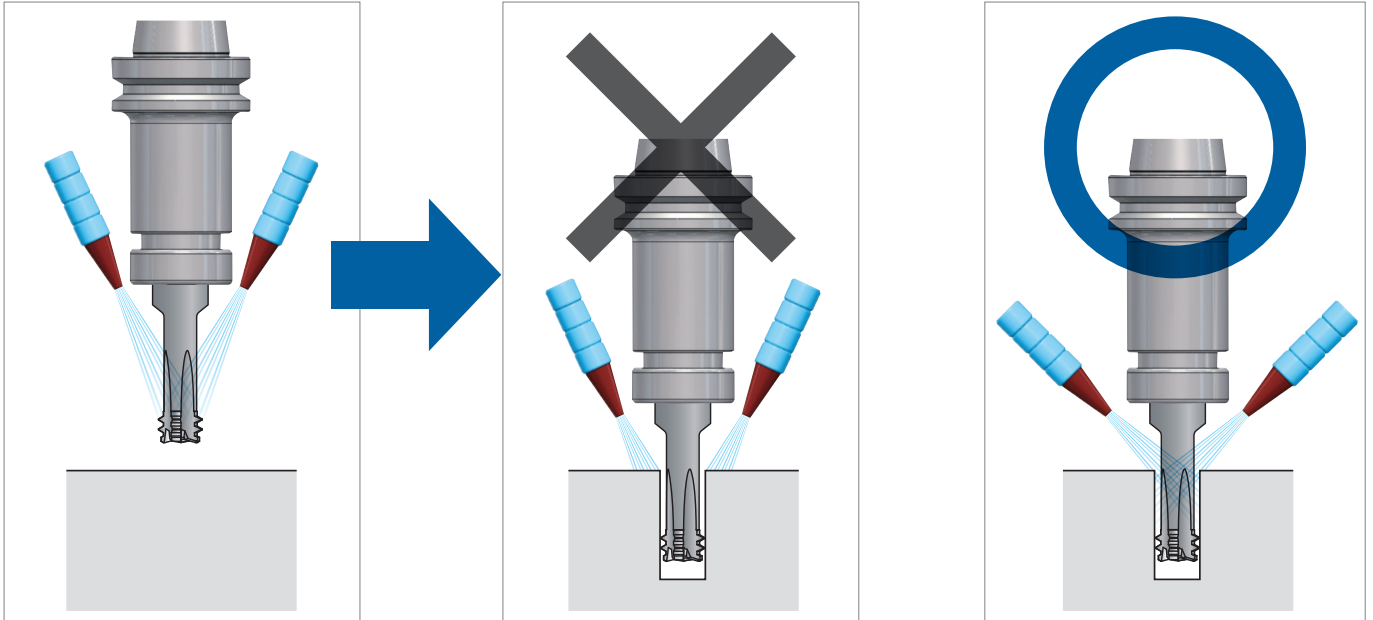

**If you are using a machining center with a through-spindle coolant system, the use of coolant through collet is recommended.**

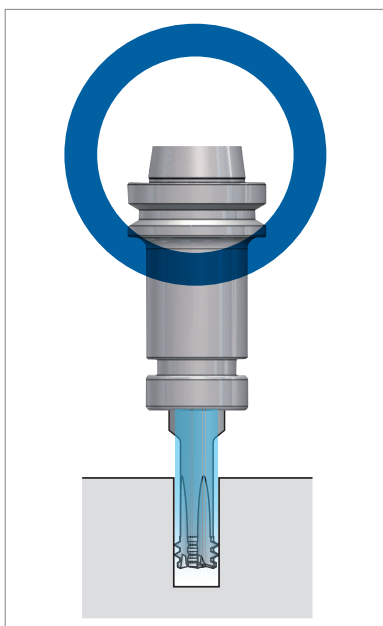

Please refer to the following table to select a suitable coolant for cutting.

Work Material	AT-2	
	Air Blow	Water-Soluble
High-hardness steel	◎	△
General steel	×	◎

◎ : Best  
 △ : Shortening of tool life  
 × : Not recommended

Water-soluble cutting fluids can be used with satisfactory result, although in some cases the durability is inferior to air-blow.



# FEATURES: WH(O)-EM-PNC

---









# WH(O)-EM-PNC: THREAD MILL WITH END-CUTTING EDGE FOR HIGH HARDNESS STEELS

**No pilot hole is required!**  
**Stable machining without chip trouble**

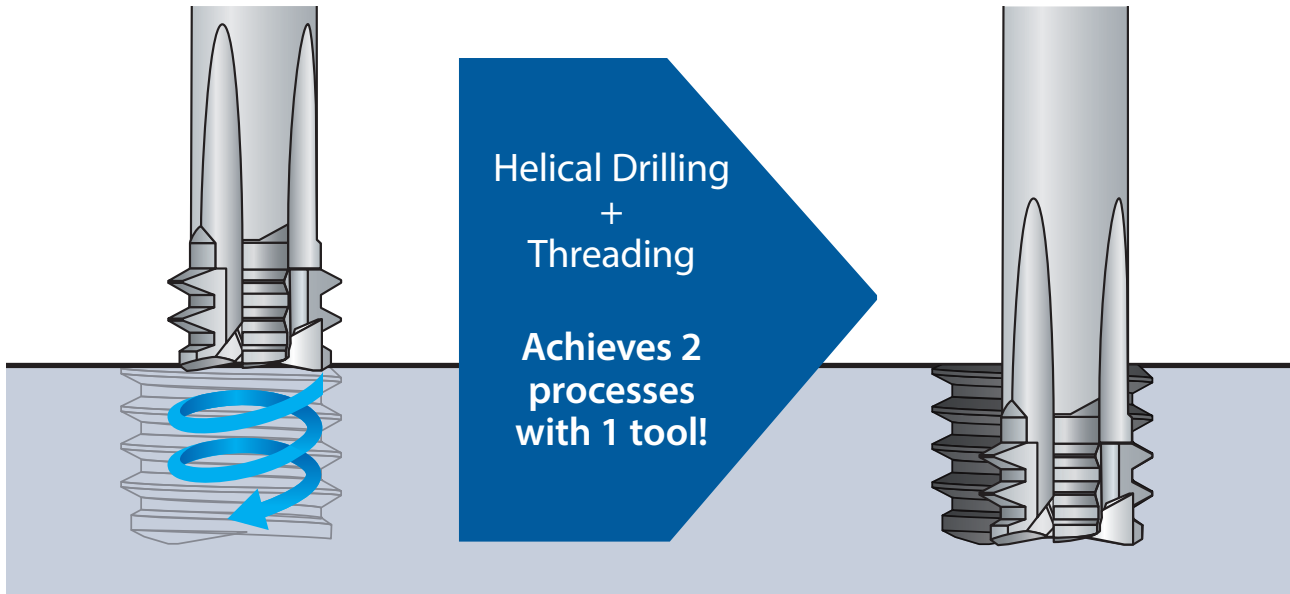

Threading | Thread milling

## WH(O)-EM-PNC: IDEAL FOR HIGHLY DIFFICULT HIGH HARDNESS STEEL APPLICATIONS!

**Helical drilling + threading can be done simultaneously, which reduces the risk of potential machining problems in the processing of high hardness steels**

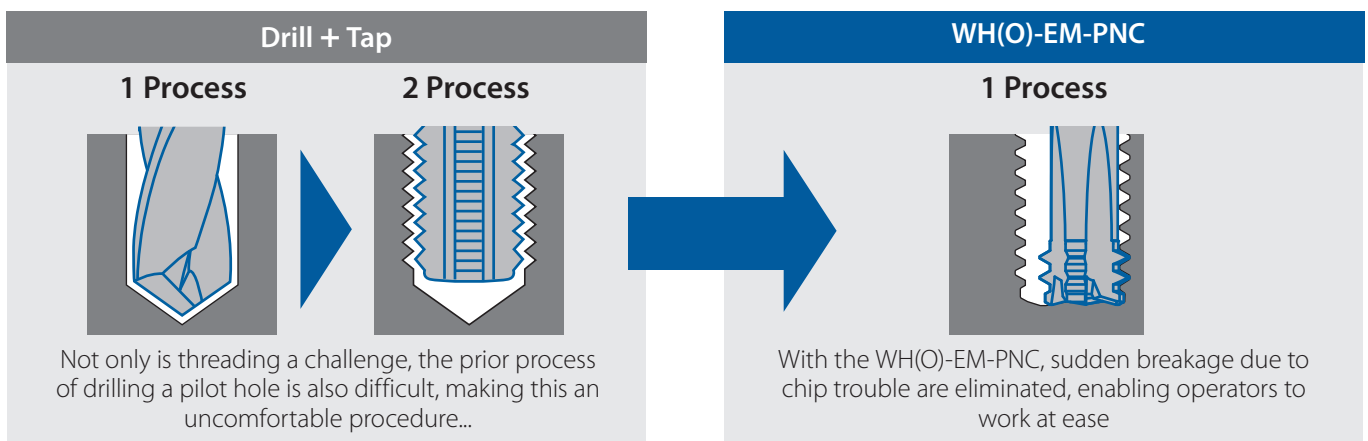

The risk of sudden tool breakage can be minimized by breaking chips into small and manageable pieces and evacuating them smoothly. Since no pilot hole is required, process integration and the risk of breakage can be avoided.

# CUTTING DATA

Tool	WH-EM-PNC M4
Work Material	1.2379 (Cold work tool steel) 60HRC
Cutting speed	30 m/min (3.082 min <sup>-1</sup> )
Feed	123 mm/min (0.01 mm/t)
Depth of cut	8 mm
Coolant	Airblow
Machine	Exeron HSC600
Interface	HSK-40
Holder	Shrink holder
Hole type	Blind hole

Tool	WH-EM-PNC M4
Work Material	1.6582 (Alloy engineering steel) 1400-1550 N/mm <sup>2</sup>
Cutting speed	50 m/min (5.137 min <sup>-1</sup> )
Feed	205 mm/min (0.01 mm/t)
Depth of cut	9 mm
Coolant	Airblow
Machine	Hermle C32U
Interface	HSK63-A
Holder	Hydraulic chuck
Hole type	Blind hole

Tool	WH-EM-PNC M4
Work Material	Vanadis (Cold work steel) 64HRC
Cutting speed	30 m/min (3.082 min <sup>-1</sup> )
Feed	123 mm/min (0.01 mm/t)
Depth of cut	8 mm
Coolant	Airblow
Machine	n.a.
Interface	n.a.
Holder	Shrink holder
Hole type	Blind hole



# KEY FEATURES: DCT



**1 Reduce setup & machining time**

RPRG values are indicated on tool shank manufactured from November 2014. Now possible to reduce the checking and correction simply by entering the RPRG value.

**2 Scale sleeve**

Measurable range 100% ~ 50% tolerance of thread size (6H)

**3 7 positions on the reading scale**

With an attached reading scale, the effective diameter's position can be confirmed at a glance.

# KEY FEATURES & BENEFITS

## 1 Reduce setup & machining time

The internal thread effective diameter, which used to be difficult to determine, can now be measured with readable values.

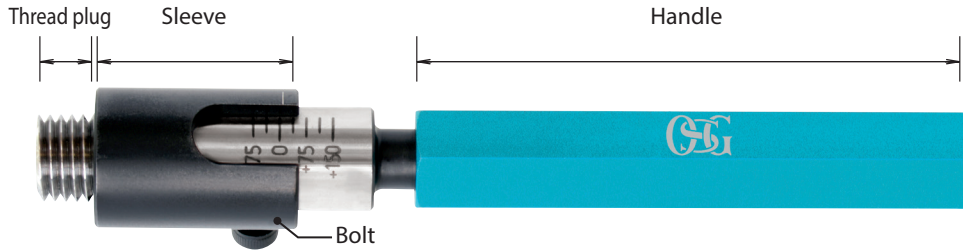

## 2 Scale sleeve

The DCT is made up of three components – the thread plug, scale sleeve and bolt for fixing the position. Measurable range from 100% ~ -50% tolerance of thread size (6H); with 7 positions on the reading scale.

Effective diameter & position relationship diagram

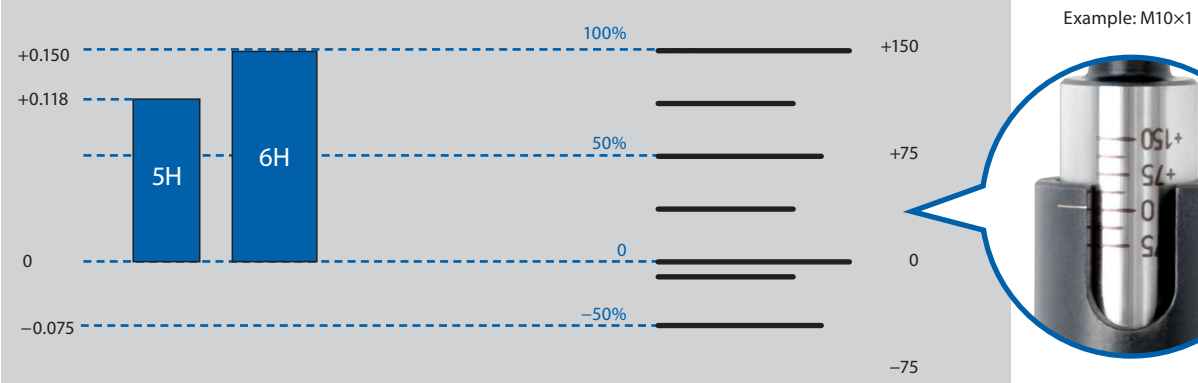

Threading | Measuring

## 3 Measuring method

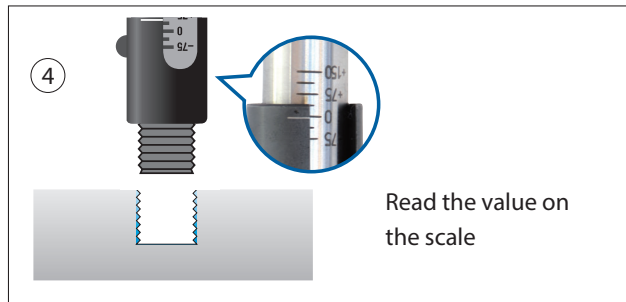
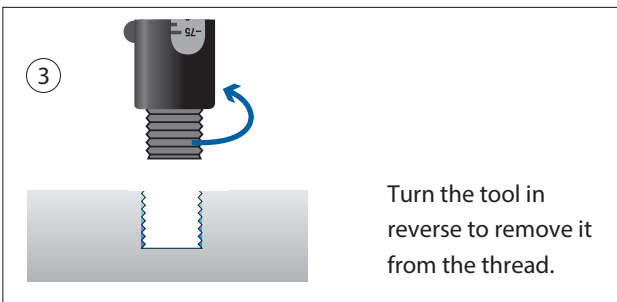
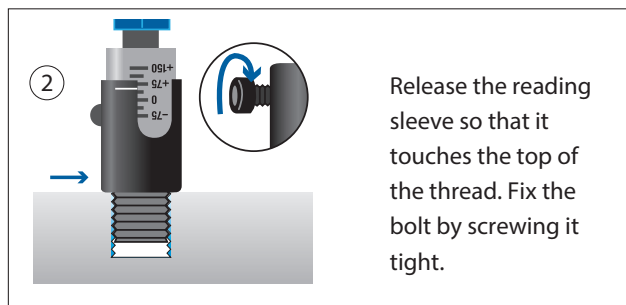
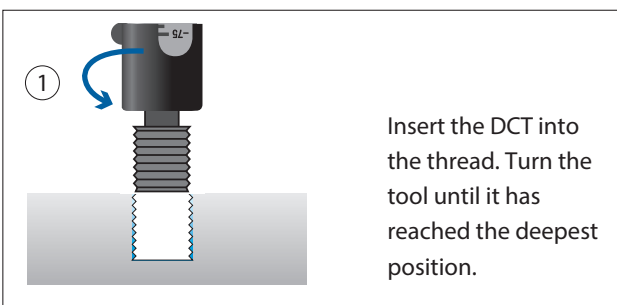

\* The reading value should be used as reference only. To inspect the screw thread please use the limit gauge (refer to p.6).  
 \* Depending on work environment this product may not be applicable.







# KEY FEATURES: E-DCT

---

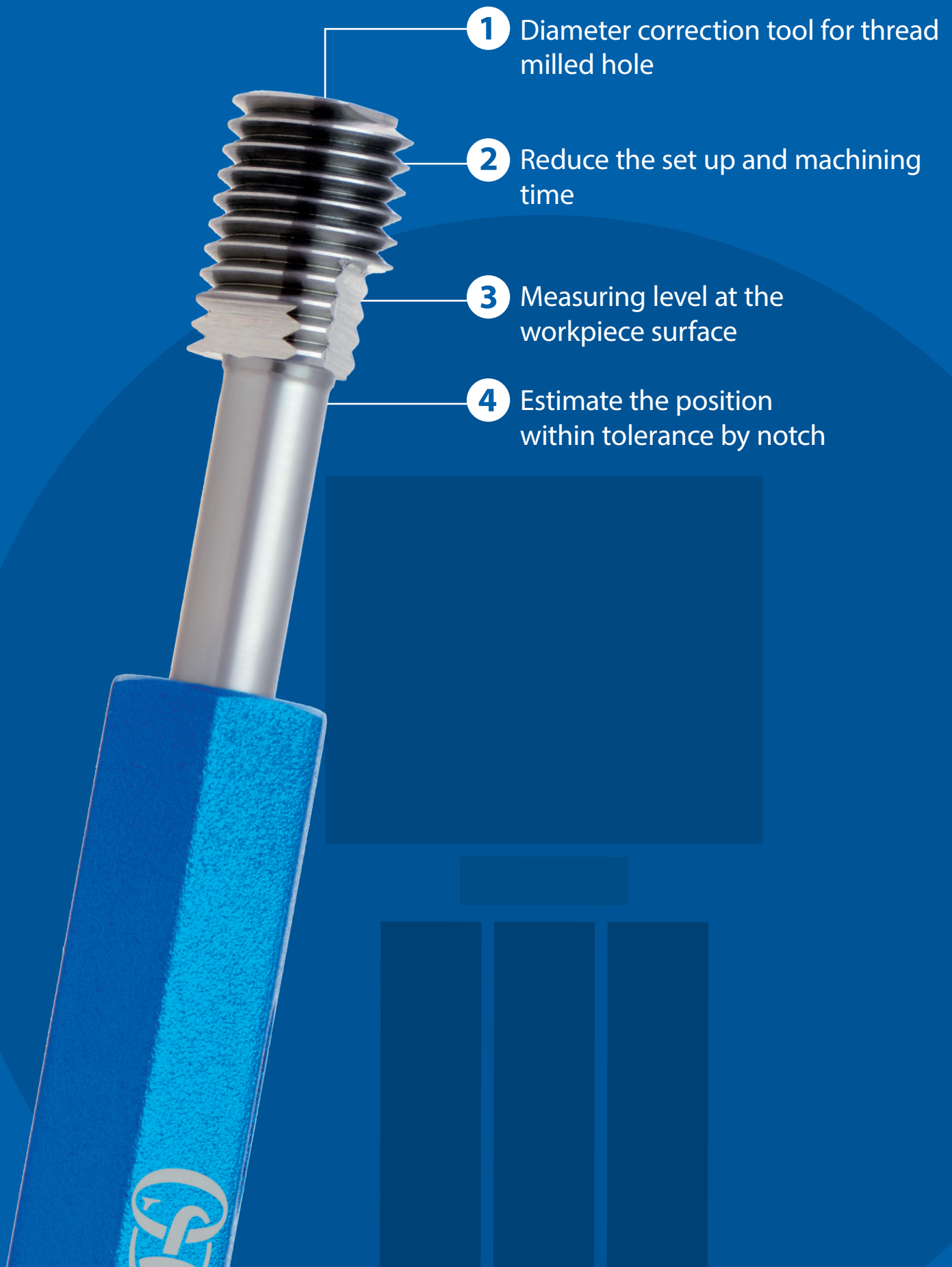

# E-DCT: KEY FEATURES & BENEFITS

## E-DCT Specification

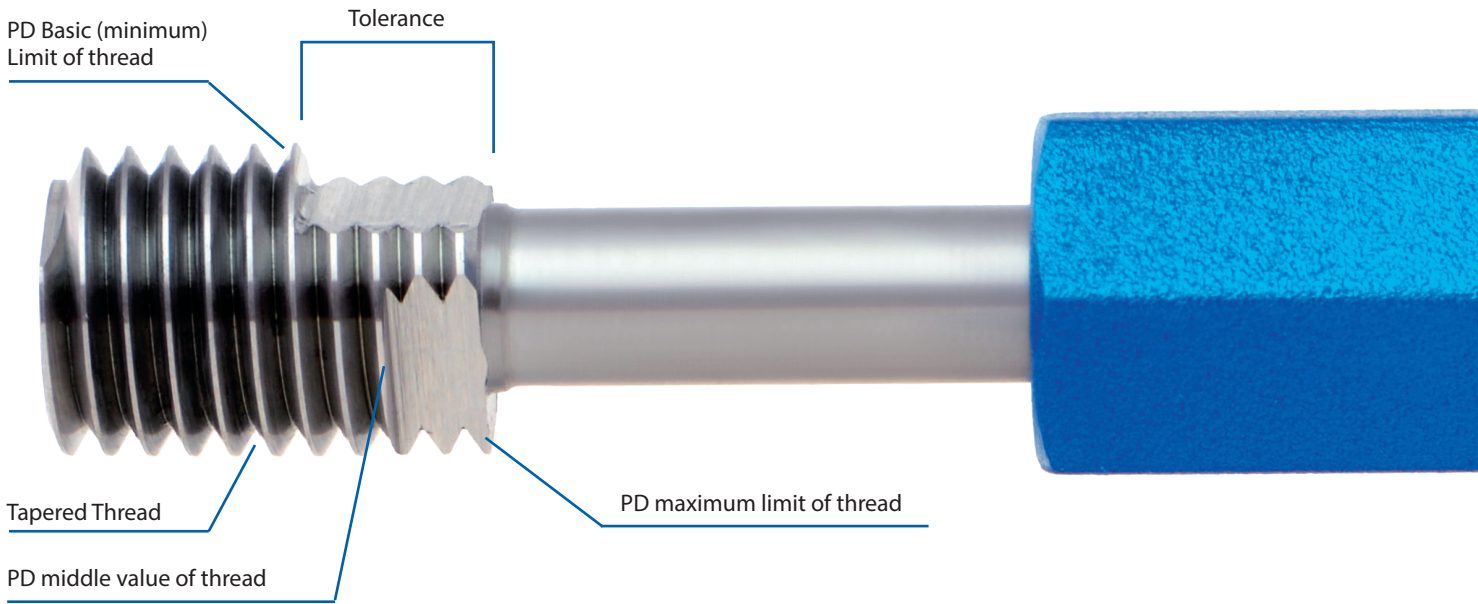

Threading | Measuring

## Judgement of internal thread with E-DCT



Hole No.	1	2	3	4	5
Position of gauge (depth) E-DCT					
GP gauge go through	NG	NG	NG (not go through)	<b>OK</b>	OK
NP gauge stop	OK	OK	OK	<b>OK</b>	NG
Judgement	NG (-)	NG (0)	NG	<b>OK</b>	NG (+)
Reason of Judgement	Smaller than Basic Pitch Diameter	Pitch Diameter is around Basic Pitch Diameter	Internal thread Tapered		Larger than maximum tolerance of Pitch Diameter

## 1. Estimate the PD by position of the notches

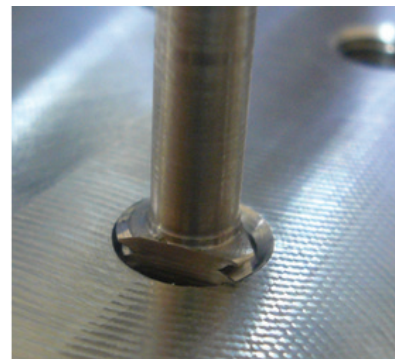
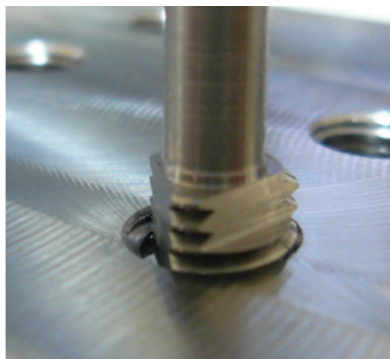
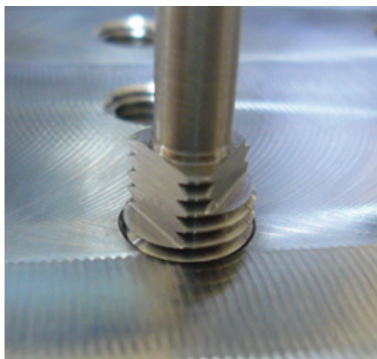

### 1.1 Work surface is between 1<sup>st</sup> notch and 2<sup>nd</sup> notch

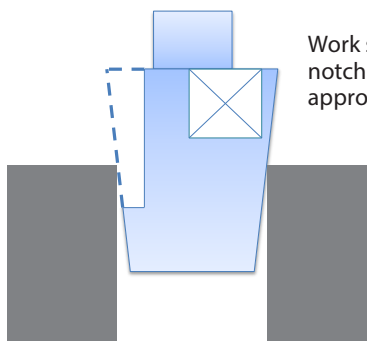
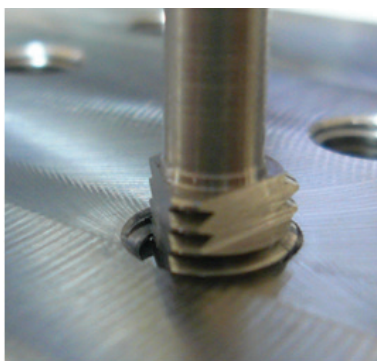

Work surface is between 1<sup>st</sup> notch and 2<sup>nd</sup> notch, which is approx.  $\frac{1}{4}$  of PD tolerance.

Example: M10X1.5 6H  
Tolerance  
9.026 +0.180 / 0  
 $+0.180 \times \frac{1}{4} = +0.045$

**PD of the thread is about +0.045**

### 1.2 Work surface is between 2<sup>nd</sup> notch and 3<sup>rd</sup> notch

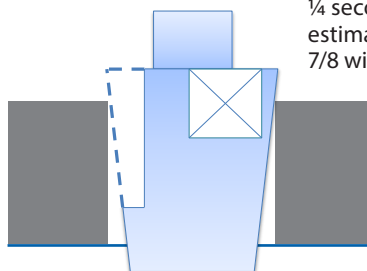
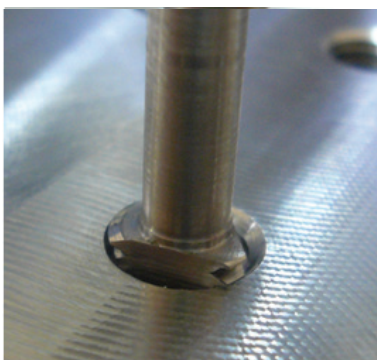

Work surface is at upper position about  $\frac{1}{4}$  second and third notch. So if you can estimate PD is about  $\frac{7}{8}$  within tolerance.

Example: M10X1.5 6H  
Tolerance  
9.026 +0.180 / 0  
 $+0.180 \times \frac{7}{8} = +0.158$

**PD of the thread is about +0.160**

## 1.3 Work surface is below the first notch (minimum limit)

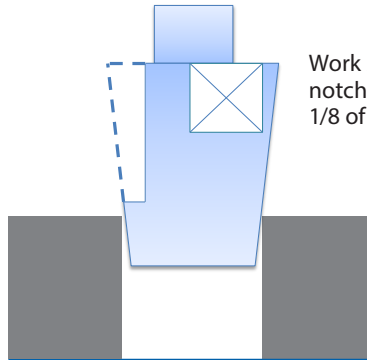
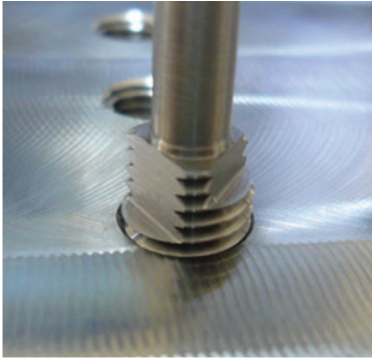

Work surface is below the first notch (Bottom Limit), about 1/8 of PD tolerance.

Example: M10X1.5 6H  
Tolerance  
9.026 +0.180 / 0  
+0.180X -1/8=-0.023

**PD of the thread is about -0.020. (Not pass for small PD)**

## 1.4 Work surface is over the 3<sup>rd</sup> notch (maximum limit)

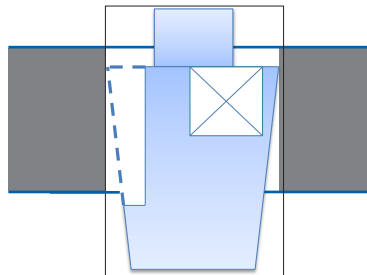
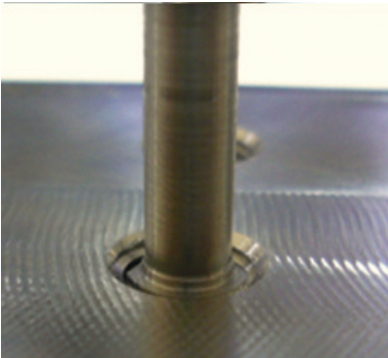

Work surface is over the 3rd notch (maximum Limit), about 1/8 of PD tolerance.

Example: M10X1.5 6H  
Tolerance  
9.026 +0.180 / 0  
+0.180X +9/8= +0.203

**PD of the thread is about +0.203. (Not pass for large PD)**

## How to calculate the correction value?

- 1) After threadmilling inspect the female thread with a plug gauge GP-NP.
- 2) After process 1), inspect position of pitch diameter with "E-DCT"
- 3) Notch ① indicates the tolerance of the pitch diameter.  
Notch ② indicates medium value of tolerance and over.



E-DCT shows pitch diameter value is around 0 in the below photo.



Ex) M10X1.5-6H Tolerance of pitch diameter is 0.180  
pitch diameter value is around 0 as show on left photo.  
If target value is 75% of tolerance , threadmill should rotate larger.

Correction value should be . . . . .

- Based on diameter =  $0.180 \times 75\% = 0.135$
- Based on semi-diameter =  $0.135 / 2 = 0.068$

Tolerance of pitch diameter is marked on shank of E-DCT.

Tolerance of pitch diameter x ratio of notch(%) = correction value.





# E-DCT

Threading | Measuring | UNJC UNJF



- Diameter correction tool for thread mill
- Reduce the set up and machining time

Threading | Measuring

UNJC

UNJF

For 3B

EDP	Thread size
G1609623	1/4 - 20 UN(J)C
G1609624	1/4 - 28 UN(J)F
G1609625	5/16 - 18 UN(J)C
G1609626	5/16 - 24 UN(J)F
G1609627	3/8 - 16 UN(J)C
G1609628	3/8 - 24 UN(J)F
G1609631	1/2 - 13 UN(J)C
G1609632	1/2 - 20 UN(J)F
G1609635	5/8 - 11 UN(J)C
G1609636	5/8 - 18 UN(J)F
G1609638	3/4 - 16 UN(J)F

For EG-3B Helicoil

EDP	Thread size
G1609723	1/4 - 20 EG-UN(J)C
G1609724	1/4 - 28 EG-UN(J)F
G1609726	5/16 - 24 EG-UN(J)F
G1609728	3/8 - 24 EG-UN(J)F
G1609731	1/2 - 13 EG-UN(J)C
G1609732	1/2 - 20 EG-UN(J)F
G1609736	5/8 - 18 EG-UN(J)F
G1609738	3/4 - 16 EG-UN(J)F

UNJC UNJF













## SWEDEN

Branch office of OSG SCANDINAVIA  
Singelgatan 7  
212 28 Malmö  
Sweden  
Tel: +46 40 41 22 55  
osg@osg-scandinavia.com

## OSG SCANDINAVIA

(For Scandinavian countries)  
Langebjergvaenget 16  
4000 Roskilde  
Denmark  
Tel: +45 46 75 65 55  
osg@osg-scandinavia.com

## OSG NETHERLANDS

Bedrijfsweg 5  
3481 MG Harmelen  
The Netherlands  
Tel: +31 348 44 2764  
info@osg-nl.com

## OSG UK

Kelsey Close, Attleborough Fields Ind Est,  
CV11 6RS, Nuneaton  
United Kingdom  
Tel: +44 (0) 1827 720 013  
uk\_sales@osg-uk.com

## OSG EUROPE LOGISTICS

Avenue Lavoisier 1  
B-1300 Z.I. Wavre - Nord  
Belgium  
Tel: +32 10 23 05 07  
info@osgeurope.com

## OSG BELUX

Avenue Lavoisier 1  
B-1300 Z.I. Wavre - Nord  
Belgium  
Tel: +32 10 23 05 11  
info@osg-belgium.com

## OSG IBÉRICA

Bekolarra 4  
E - 01010 Vitoria-Gasteiz  
Spain  
Tel: +34 945 242 400  
osg.iberica@osg-ib.com

## OSG FRANCE

Parc Icade, Paris Nord 2  
Immeuble "Le Rimbaud"  
22 Avenue des Nations  
CS66191 - 93420 Villepinte  
France  
Tel: +33 1 49 90 10 10  
sales@osg-france.com

## OSG ITALY

Via Ferrero, 65 A/B  
I - 10098 Rivoli  
Italy  
Tel: +39 0117705211  
info@osg-italia.it



# OSG IN EUROPE

## CZECH REPUBLIC, SLOVAKIA, HUNGARY

OSG Europe Logistics S.A.  
Slovakia, organizačná zložka  
Račianska 22/A, Bratislava 831 02  
Slovakia  
Tel.: +421 24 32 91 295  
info@osgeurope.com

## OSG POLAND

ul. Spółdzielcza 57  
05-074 Halinów  
Polska  
Tel: +22 760 82 71  
Mob. +48 570 677 711  
osg@osg-poland.com

## OSG ROMANIA SRL

25C, Bucuresti-Magurele Street (Sector 5)  
051431 Bucuresti  
România  
Tel: +40 21 322 07 47  
info@osgromania.ro

## OSG TURKEY

Rami Kişla Cad.No:56 Eyüp  
Istanbul 34056  
Turkey  
Tel: +90 212 565 24 00  
Fax: +90 212 565 44 00  
info@osg-turkey.com

## Vischer & Bolli AG

Machining and Workholding  
Im Schossacher 17  
CH-8600 Dübendorf  
Switzerland  
Tel.: +41 44 802 15 15  
info@vb-tools.com

## OSG GERMANY

Karl-Ehmann-Str. 25  
D - 73037 Göppingen  
Germany  
Tel: +49 7161 6064 - 0  
Fax: +49 7161 6064 - 444  
info@osg-germany.de



*shaping your dreams*

**OSG EUROPE LOGISTICS**

Avenue Lavoisier 1  
B-1300 Z.I. Wavre - Nord - Belgium  
Tel: +32 10 23 05 07  
info@osgeurope.com

**OSG POLAND Sp. z o.o.**

Spółdzielcza 57  
05-074 Halinów - Poland  
Tel: +22 760 82 71  
osg@osg-poland.com

**OSG ROMANIA SRL**

25C, Bucuresti-Magurele Street (Sector 5)  
051431 Bucuresti - România  
Tel: +40 21 322 07 47  
info@osgromania.ro

**OSG BELUX**

Avenue Lavoisier 1  
B-1300 Z.I. Wavre - Nord - Belgium  
Tel: +32 10 23 05 11  
info@osg-belgium.com

**OSG GERMANY**

Karl-Ehmann-Str. 25  
D - 73037 Göppingen - Germany  
Tel: +49 7161 6064 - 0  
Fax: +49 7161 6064 - 444  
info@osg-germany.de

**AUSTRIA**

Branch office of OSG GERMANY  
Messestraße 11  
A-6850 Dornbirn  
Tel: +49 7161 6064-0  
info@osg-germany.de

**OSG FRANCE**

Parc Icade, Paris Nord 2  
Immeuble "Le Rimbaud"  
22 Avenue des Nations  
CS66191 - 93420 Villepinte - France  
Tel: +33 1 49 90 10 10  
sales@osg-france.com

**OSG SCANDINAVIA**

(For Scandinavian countries)  
Langebjergvaenget 16  
4000 Roskilde - Denmark  
Tel: +45 46 75 65 55  
osg@osg-scandinavia.com

**OSG ITALIA**

Via Ferrero, 65 A/B3  
I - 10098 Rivoli - Italy  
Tel: +39 0117705211  
info@osg-italia.it

**OSG NETHERLANDS**

Bedrijfsweg 5 - 3481 MG Harmelen  
Tel: +31 348 44 2764  
info@osg-nl.com

**SWEDEN**

Branch office of OSG SCANDINAVIA  
Singelgatan 7  
212 28 Malmö - Sweden  
Tel: +46 40 41 22 55  
osg@osg-scandinavia.com

**Vischer & Bolli AG**

Machining and Workholding  
Im Schossacher 17  
CH-8600 Dübendorf  
T +41 44 802 15 15  
info@vb-tools.com

**OSG UK**

Kelsey Close, Attleborough Fields Ind Est,  
CV11 6RS, Nuneaton, United Kingdom.  
Tel: +44 1827 720 013  
uk\_sales@osg-uk.com

**OSG IBERICA**

Bekolarra 4  
E - 01010 Vitoria-Gasteiz - Spain  
Tel: +34 945 242 400  
osg.iberica@osg-ib.com

**CZECH, SLOVAKIA, HUNGARY**

OSG Europe Logistics S.A.  
Slovakia organizacna zlozka  
Racianská 22/A, SK-83102 Bratislava  
Slovakia  
Tel. +421 24 32 91 295  
Orders-osgsvk@osgeurope.com

**OSG TURKEY**

Rami Kışla Cad.No:56 Eyüp  
Istanbul 34056 - Turkey  
Tel+90 212 565 24 00  
Fax: +90 212 565 44 00  
info@osg-turkey.com

**OSG EUROPE LOGISTICS S.A.**

03/2022 - All rights reserved. © OSG Europe 2022.

The contents of this catalogue are provided to you for viewing only. They are not intended for reproduction either in part or in whole in this or other medium. They cannot be copied, used to create derivation work or used for any reason, by means without the express, written permission of the copyright owner. If prices are stated, they are netto unit-prices and any eventual tax(es) have to be added. The company is not responsible for any printing error in technical, price and/or any other data.

Tool specifications subject to change without notice.

[www.osgeurope.com](http://www.osgeurope.com)

